

# **PULSED POWER SYSTEM**

## **脈衝功率系統**



**Po-Yu Chang**

**Institute of Space and Plasma Sciences, National Cheng Kung University**

**2023 Fall Semester**

**Tuesday 9:10-12:00**

**Lecture 14**

**<http://capst.ncku.edu.tw/PGS/index.php/teaching/>**

**Online courses:**

**<https://nckucc.webex.com/nckucc/j.php?MTID=md577c3633c5970f80cbc9e821927e016>**

# Final project and final presentation

---



- **Final project:**
  - **Due on 1/2.**
- **Final presentation:**
  - **12/26 10:00.**
  - **15 mins for each person**
  - **Applications of pulsed-power system**

# Outlines

---



- Power and voltage adding
  - Marx generator
  - LC generator
  - Line pulse transformers
  - Induction voltage adder (IVA)
  - Linear induction accelerator (LIA)
  - Linear transformer driver (LTD)
- **Diagnostics**
  - **Voltage measurement**
  - **Current measurement**
- Applications of pulsed-power system

# Diagnostics

---



- **The basic electrical quantities are always the electromagnetic fields  $E$  and  $B$  from which pulse current and voltage must be derived.**
- **A suitable sensor does not perturb the fields to be measured is achieved with**
  - **capacitive sensors;**
  - **inductive sensors;**
  - **electro-optical methods;**
  - **resistive voltage dividers. It may create weak points in the high-voltage insulation.**



# Electromagnetic field sensors



- Rapidly changing electromagnetic fields, i.e.,  $\frac{d\vec{B}}{dt}$  or  $\frac{d\vec{E}}{dt}$ 
  - induced currents / voltages in the conductors of a sensor.
  - only consider electrically short sensors:
    - size  $< \lambda$  of the field where  $\lambda$  is the scale length or wavelength.
    - or  $d \ll c\tau_r$ , the distance of the wave that propagates where  $\tau_r$  is the pulse rise time

→ conduction current density:  $\vec{j}_c = \sigma \vec{E}$

displacement current density:  $\vec{j}_d = \frac{\partial \vec{D}}{\partial t}$

Maxwell's eq:

$$\nabla \times \vec{E} = -\frac{\partial \vec{B}}{\partial t}$$

$$\nabla \times \vec{H} = \frac{\partial \vec{D}}{\partial t} + \vec{j}$$

# Electromagnetic field sensors



- Ideal conducting sensor of area  $A$ :

$$i(t) = [j_c(t) + \dot{D}(t)]A = [\sigma E(t) + \epsilon \epsilon_0 \dot{E}(t)]A$$

The sensitivity depends on  $\sigma$ ,  $\epsilon$ ,  $A$ ,  $E(t)$ ,  $\dot{E}(t)$ , and  $\omega$ .

- Alternating magnetic fields  $\Rightarrow$  induce currents in conducting loops.

$$u(t) = - \oint \dot{\vec{B}}(t) d\vec{A} \approx - \dot{\vec{B}}(t) \vec{A} \quad \Leftarrow \text{if field is homogeneous.}$$

The sensitivity depends on  $A$ ,  $\dot{B}(t)$ , and  $\omega$ .

Quasistationary Fields

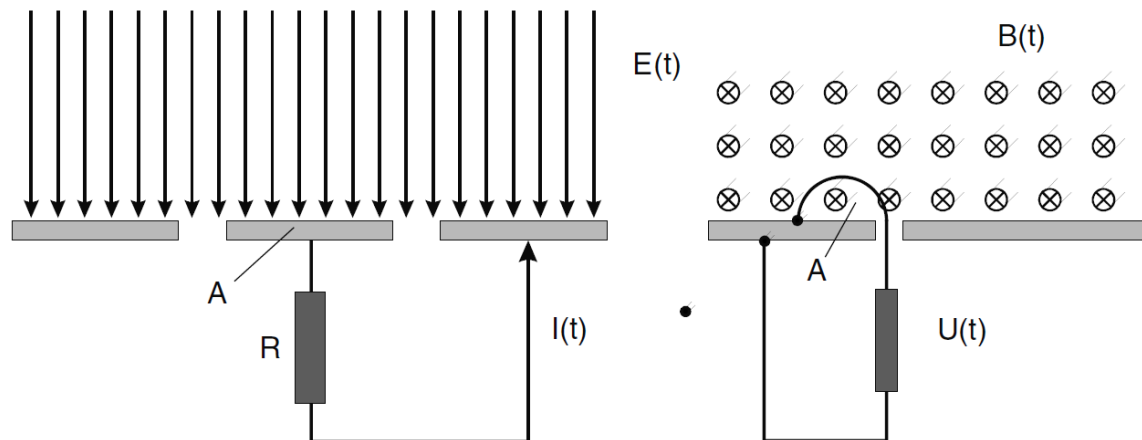

- The coupling may also couple the undesired noise.

# Capacitive/Inductive sensors

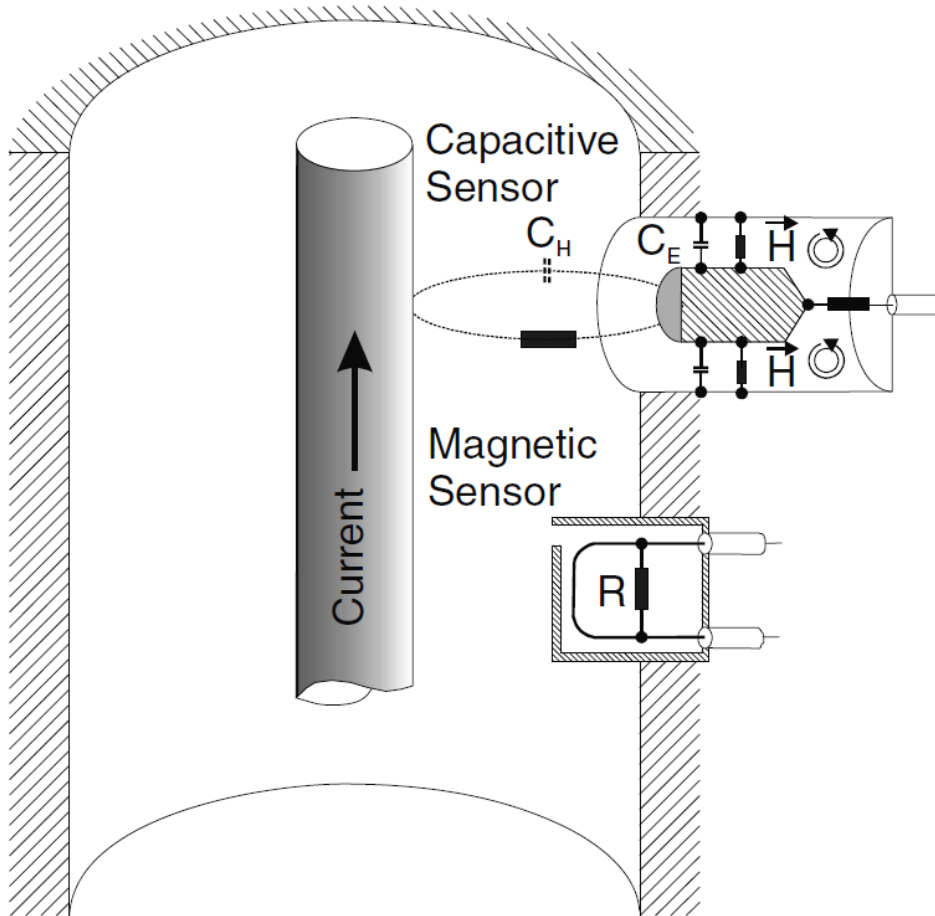

$$u(t) = \frac{C_H}{C_H + C_E} U(t)$$

$$u(t) = - \oint \dot{\vec{B}}(t) d\vec{A} = - \frac{d\phi}{dt}$$

# Capacitive sensor for voltage measurement



$$V_{in} = V_{C_1} + V_{out} \quad I_p = I_{C_2} + I_{R_S}$$

$$I_p = C_1 \frac{dV_{C_1}}{dt} \quad I_{C_2} = C_2 \frac{dV_{out}}{dt} \quad I_{R_S} = \frac{V_{out}}{R_S}$$

$$C_1 \frac{dV_{C_1}}{dt} = C_2 \frac{dV_{out}}{dt} + \frac{V_{out}}{R_S}$$

$$\frac{dV_{C_1}}{dt} = \frac{C_2}{C_1} \frac{dV_{out}}{dt} + \frac{V_{out}}{R_S C_1}$$

$$\frac{dV_{in}}{dt} = \frac{dV_{C_1}}{dt} + \frac{dV_{out}}{dt}$$

$$\frac{dV_{in}}{dt} = \left( \frac{C_1 + C_2}{C_1} \right) \frac{dV_{out}}{dt} + \frac{V_{out}}{R_S C_1}$$

$$\frac{V_{in}}{V_{out}} = \left( \frac{C_1 + C_2}{C_1} \right) + \frac{1}{sR_S C_1}$$

$$= \left( \frac{C_1 + C_2}{C_1} \right) \left[ 1 + \frac{1}{sR_S(C_1 + C_2)} \right]$$

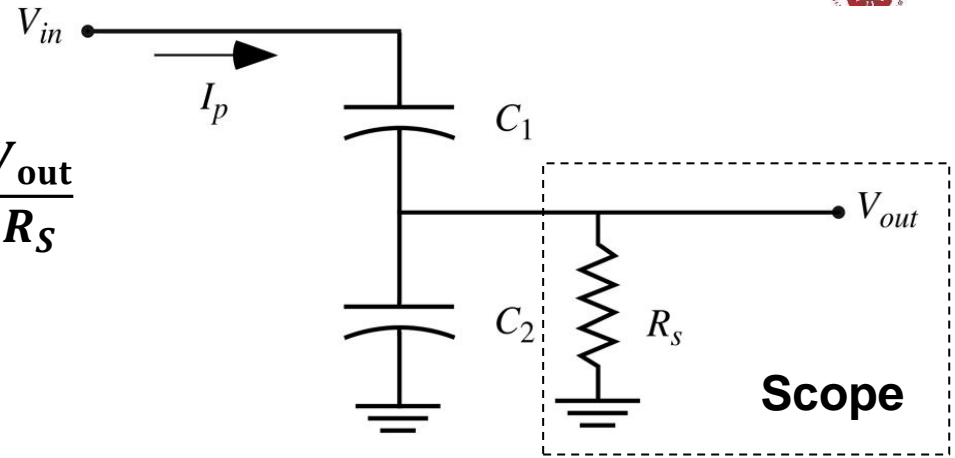

$$\omega_{3dB} = \frac{1}{R_S(C_1 + C_2)}$$

- **Low frequency:**

$$V_{out} = \frac{C_1}{C_1 + C_2} V_{in}$$

- **High frequency:**

$$V_{out} = R_S C_1 \frac{dV_{in}}{dt}$$

# Inductive sensor with RC integrator for current measurement



$$|u(t)| = \frac{d\phi}{dt} = L \frac{di}{dt} + Ri + \frac{1}{C} \int_0^t i dt'$$

$$|u(t)| = \frac{d\phi}{dt} = k \frac{di}{dt}$$

$$|u(t)| = \frac{d\phi}{dt} \approx Ri + \frac{1}{C} \int_0^t i dt'$$

$$u_s = \frac{1}{C} \int_0^t i dt' \Rightarrow C \dot{u}_s = i$$

$$u = RC \dot{u}_s + u_s$$

$$\dot{u}_s + \frac{1}{RC} u_s = \frac{1}{RC} u$$

$$\dot{u}_s e^{\frac{1}{RC}t} + \frac{1}{RC} u_s e^{\frac{1}{RC}t} = \frac{1}{RC} u e^{\frac{1}{RC}t}$$

$$\frac{d}{dt} \left( u_s e^{\frac{1}{RC}t} \right) = \frac{1}{RC} u e^{\frac{1}{RC}t}$$

$$\int d \left( u_s e^{\frac{1}{RC}t'} \right) = \frac{1}{RC} \int_0^t u e^{\frac{1}{RC}t'} dt'$$

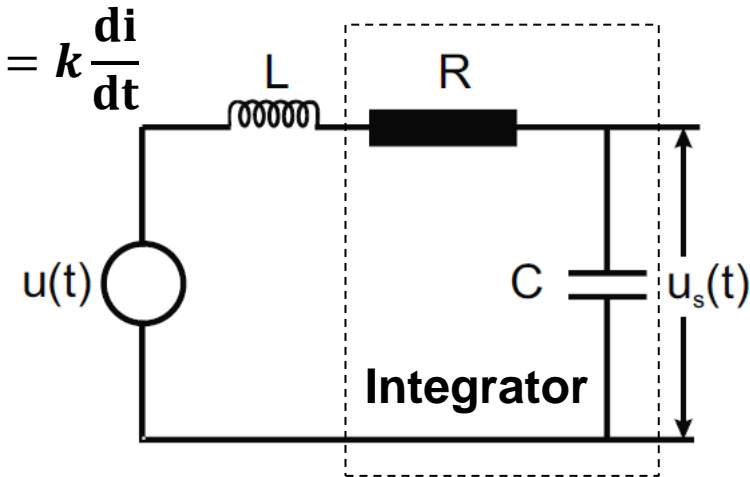

$$u_s e^{\frac{1}{RC}t} - u_s(0) = \frac{1}{RC} \int_0^t u e^{\frac{1}{RC}t'} dt'$$

$$u_s = \frac{e^{-\frac{1}{RC}t}}{RC} \int_0^t u e^{\frac{1}{RC}t'} dt' \approx \frac{1}{RC} \int_0^t u dt'$$

$$= \frac{k}{RC} i(t)$$

- Working regime:

$$RC \gg t \approx \frac{1}{\omega} \quad \omega \gg \frac{1}{RC}$$

# Rogowski coil



- In situ calibration is needed to obtain  $k$ .  $|u(t)| = \frac{d\phi}{dt} = k \frac{di}{dt}$
- If in situ calibration is not possible, Rogowski coil instead of a simple current loop is used.
- Rogowski coil is a coil consisting of many windings lined up in a toroidal configuration encircling the current path.

$$\oint \vec{B} \cdot d\vec{l} = \mu_0 I \quad B = \frac{\mu_0}{2\pi r} I$$

$$\phi_1 = BA = \frac{\mu_0 A}{2\pi r} I$$

$$|u| = \frac{d\phi}{dt} = N \frac{d\phi_1}{dt} = \frac{\mu_0 AN}{2\pi r} \frac{dI}{dt}$$

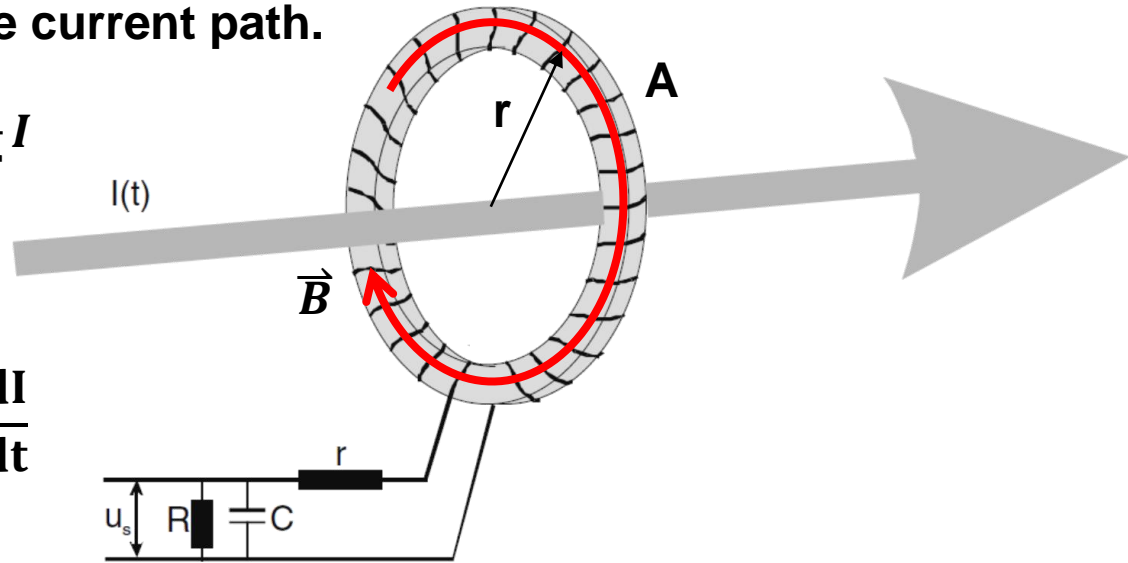

$$u_s(t) = \frac{1}{RC} \int u dt = \frac{1}{RC} \frac{\mu_0 AN}{2\pi r} \int \frac{dI}{dt} dt = \frac{1}{RC} \frac{\mu_0 AN}{2\pi r} I$$

# Assumption for Rogowski coil



- Neglect the spatial dependence of the magnetic induction over the area  $A$
- Cross section  $A$  are all the same.
- Number of turns per unit length is const.
- When #/ of turns increase,  
L may be large  
 $\Rightarrow L\omega \ll R$  may not be met.  
 $\Rightarrow$  use the opposite regime  
where  $L\omega \gg R$ .  
It becomes “self-integrated.”

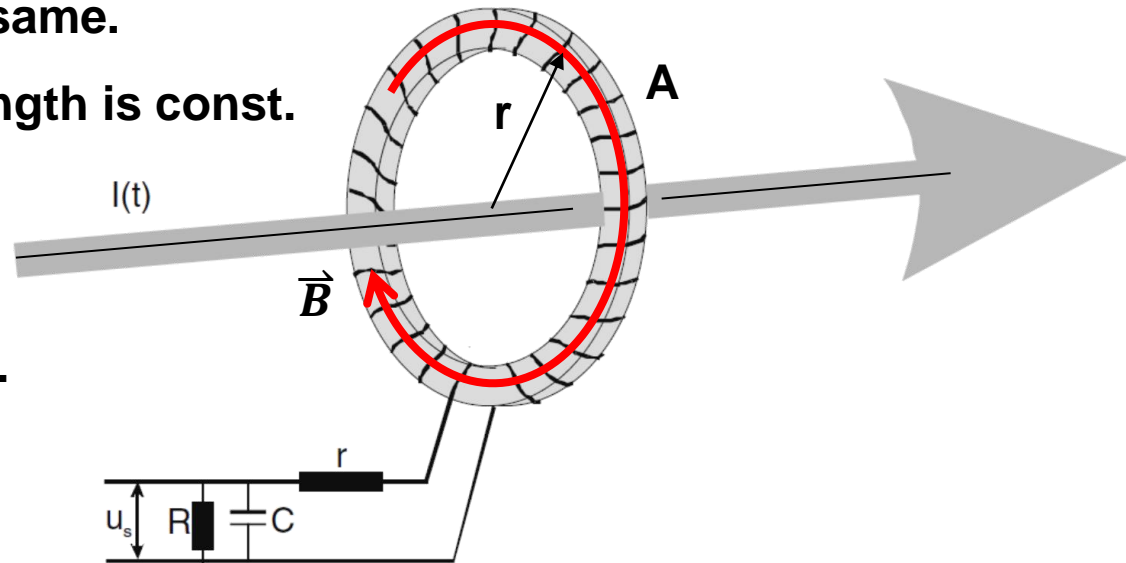

# Self-integrated current monitor where $L\omega \gg R$



$$R_o \gg R \quad L\omega \gg R_o + R$$

$$u - L \frac{dI}{dt} = u_s \quad u_s = IR_o$$

$$u - \frac{L}{R_o} \frac{du_s}{dt} = u_s \quad \frac{du_s}{dt} + \frac{R_o}{L} u_s = \frac{R_o}{L} u$$

$$e^{-\frac{R_o}{L}t} \frac{d}{dt} \left( u_s e^{\frac{R_o}{L}t} \right) = \frac{R_o}{L} u \quad \frac{d}{dt} \left( u_s e^{\frac{R_o}{L}t} \right) = \frac{R_o}{L} u e^{\frac{R_o}{L}t}$$

$$u_s e^{\frac{R_o}{L}t} - u_s(0) = \frac{R_o}{L} \int u e^{\frac{R_o}{L}t'} dt'$$

$$u_s = \frac{R_o}{L} e^{-\frac{R_o}{L}t} \int u e^{\frac{R_o}{L}t'} dt' \quad L\omega \gg R_o \quad t \frac{R_o}{L} \ll 1 \quad |u| = \frac{d\phi}{dt} = N \frac{d\phi_1}{dt} = \frac{\mu_o AN}{2\pi r} \frac{dI}{dt}$$

$$u_s = \frac{R_o}{L} \int u dt' = \frac{R_o}{L} \int \frac{\mu_o AN}{2\pi r} \frac{dI}{dt} dt' = \frac{R_o \mu_o AN}{L 2\pi r} I \quad \Leftarrow \text{self integrated!}$$

$$u_s \propto R_o$$

- Ferromagnetic material in the torus may be used to increase inductance.

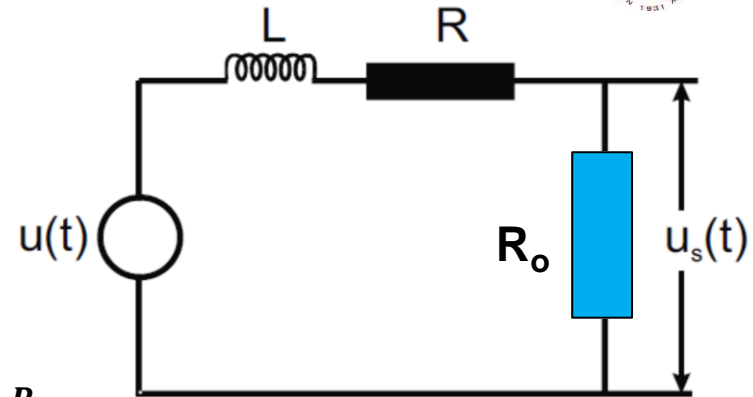



# Additional note for Rogowski coil



- To reduce the capacitive coupling, wrap the Rogowski coil with a slotted metallic case. However, it needs to let the flux go into the winding. NO closed loop is allowed.
- A large flux penetrating the main opening of the torus may induce additional voltage. To compensate for this signal, feed one end of the wire back through the windings

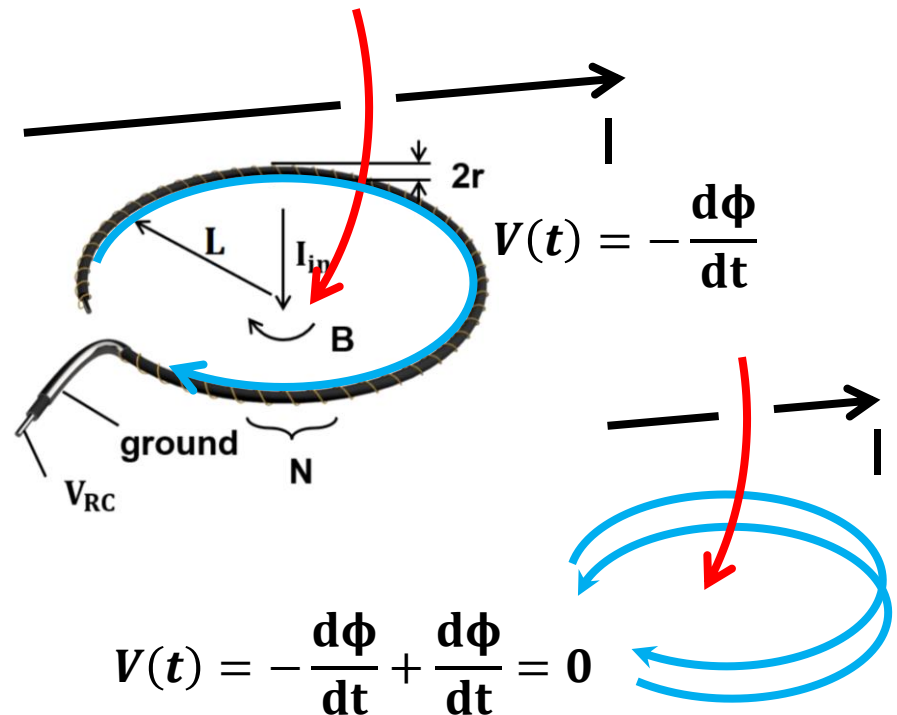
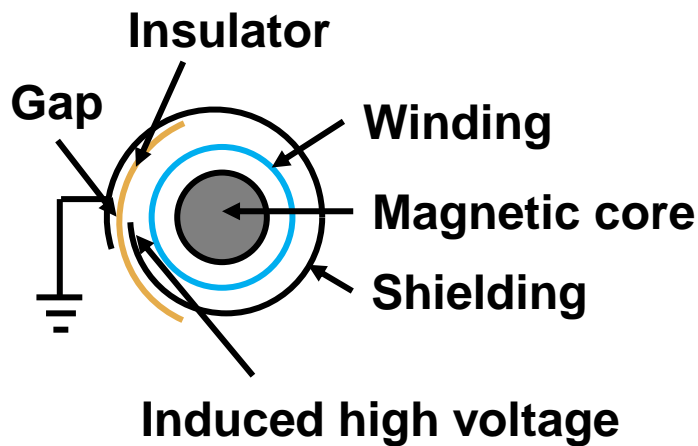

# Fabrication of the Rogowski coil using a coaxial cable

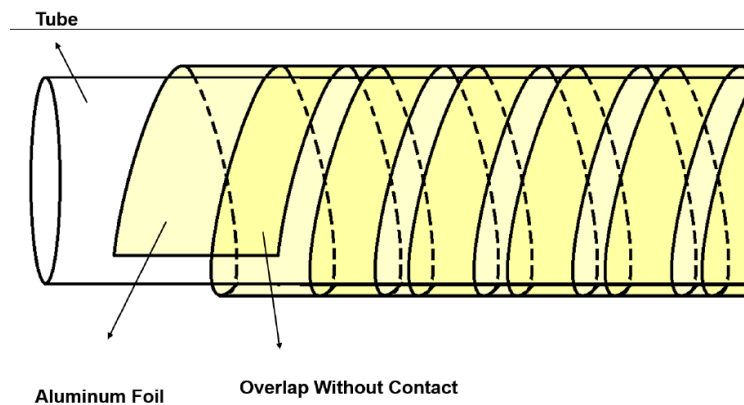
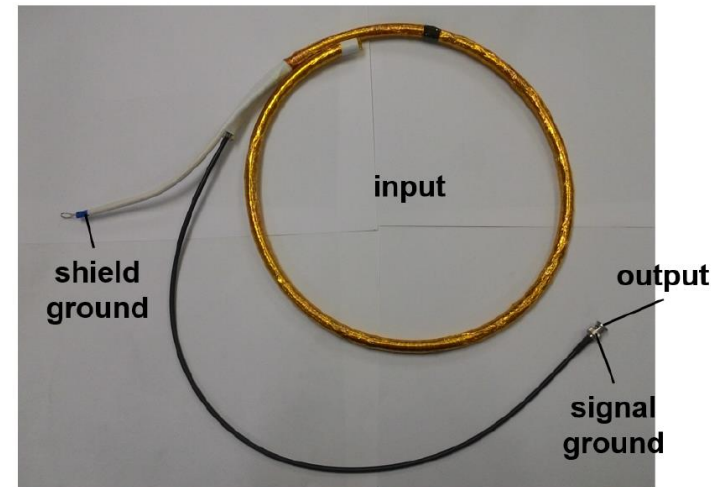
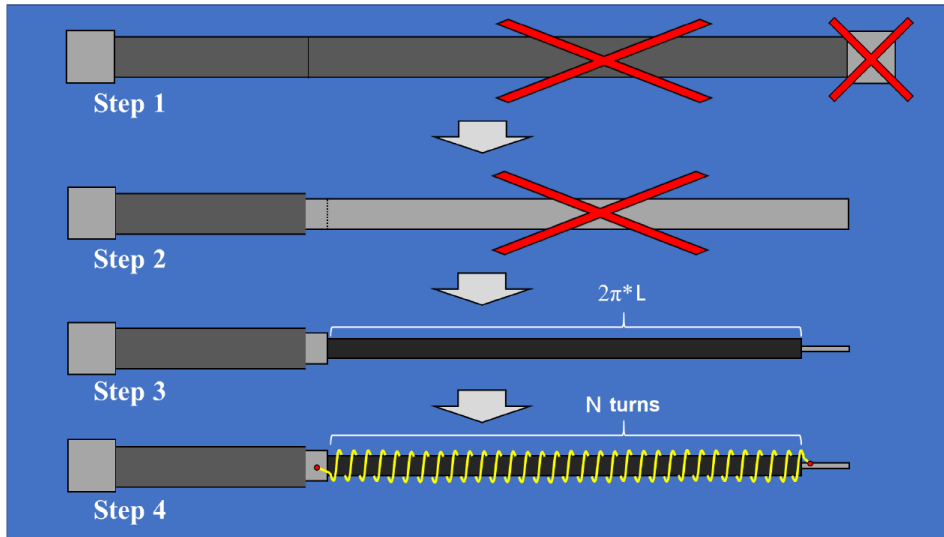

# Other ways of making compensated Rogowski coil



- Bifilar

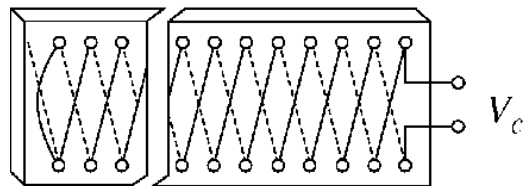

(a)

- Inner compensating coil

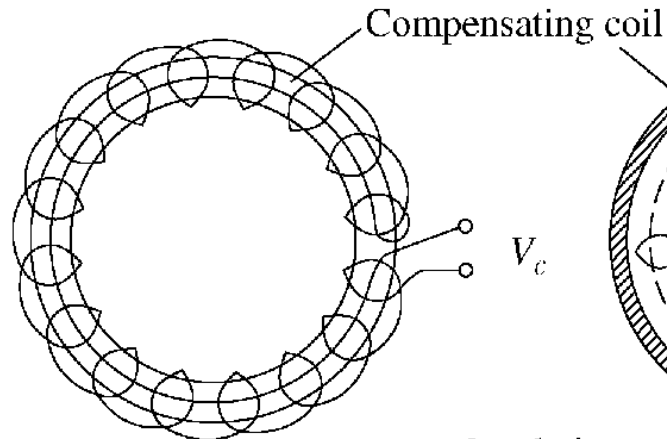

(b)

- Outer compensating coil

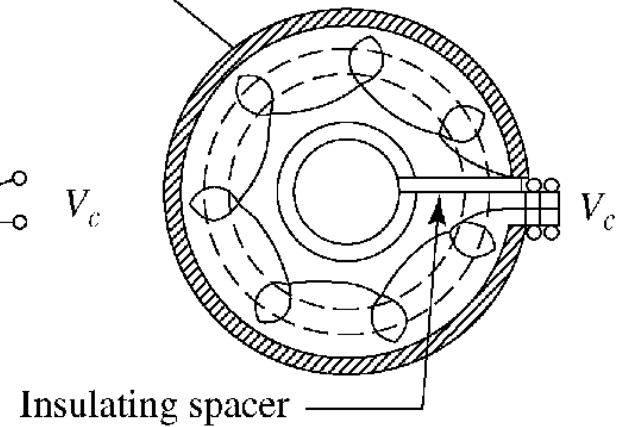

(c)

# Current-viewing resistors (CVRs)



- It is also called “shunts.”
- Measurement of the voltage drop across a resistor of known value, incorporated into the circuit.

$$I = \frac{V}{R}$$

- The current path and the measuring circuit are coupled not only through the Ohmic resistor but also magnetically.

=> preferable to place the metering contact in a field-free space or reduce the coupling efficiency.

- Cylindrically symmetric shunt geometry provides an zero magnetic coupling.

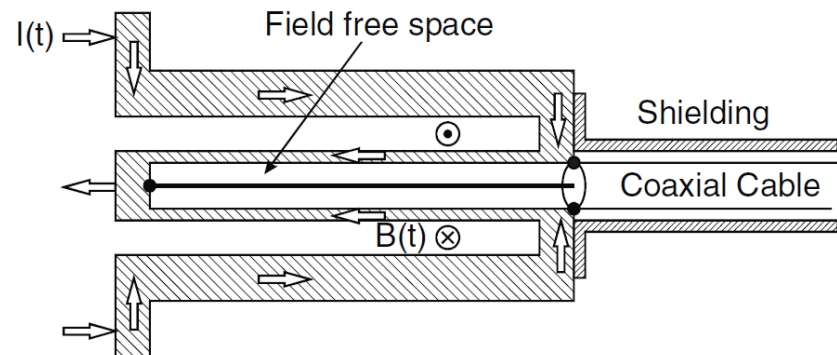

# Shunts



- **Folded strip shunt**

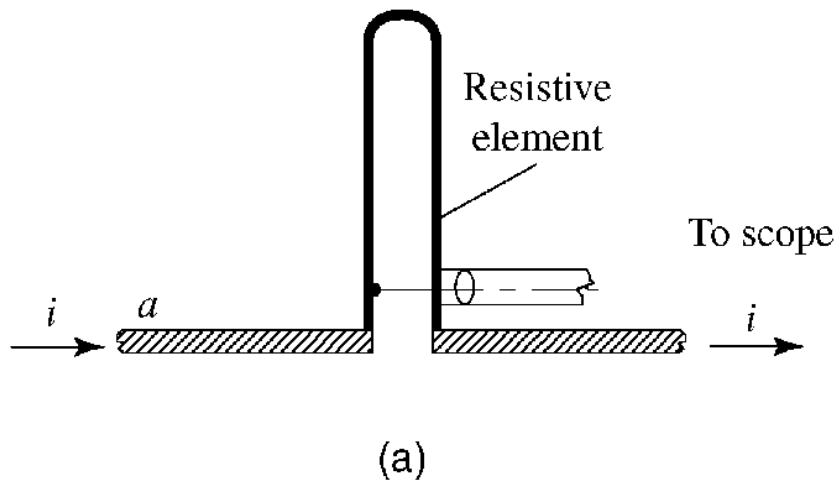

- **Parallel twisted shunt**

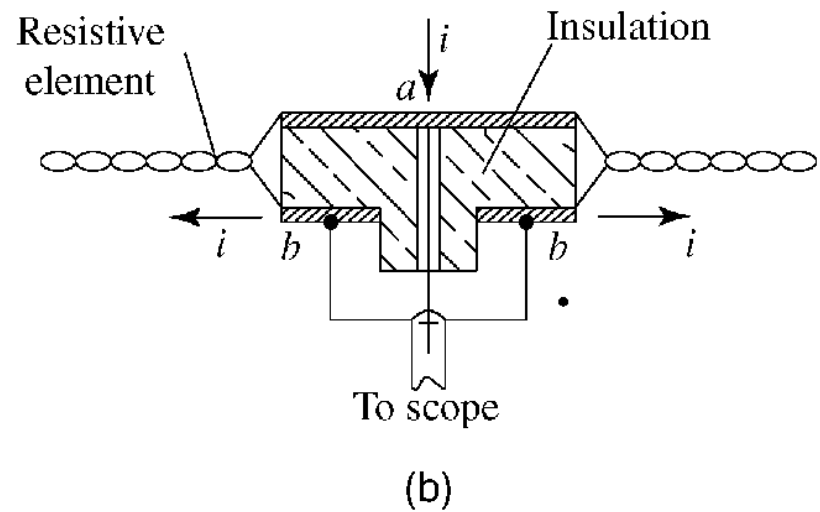

# CVR integrated into the outer conductor of a coaxial transmission line

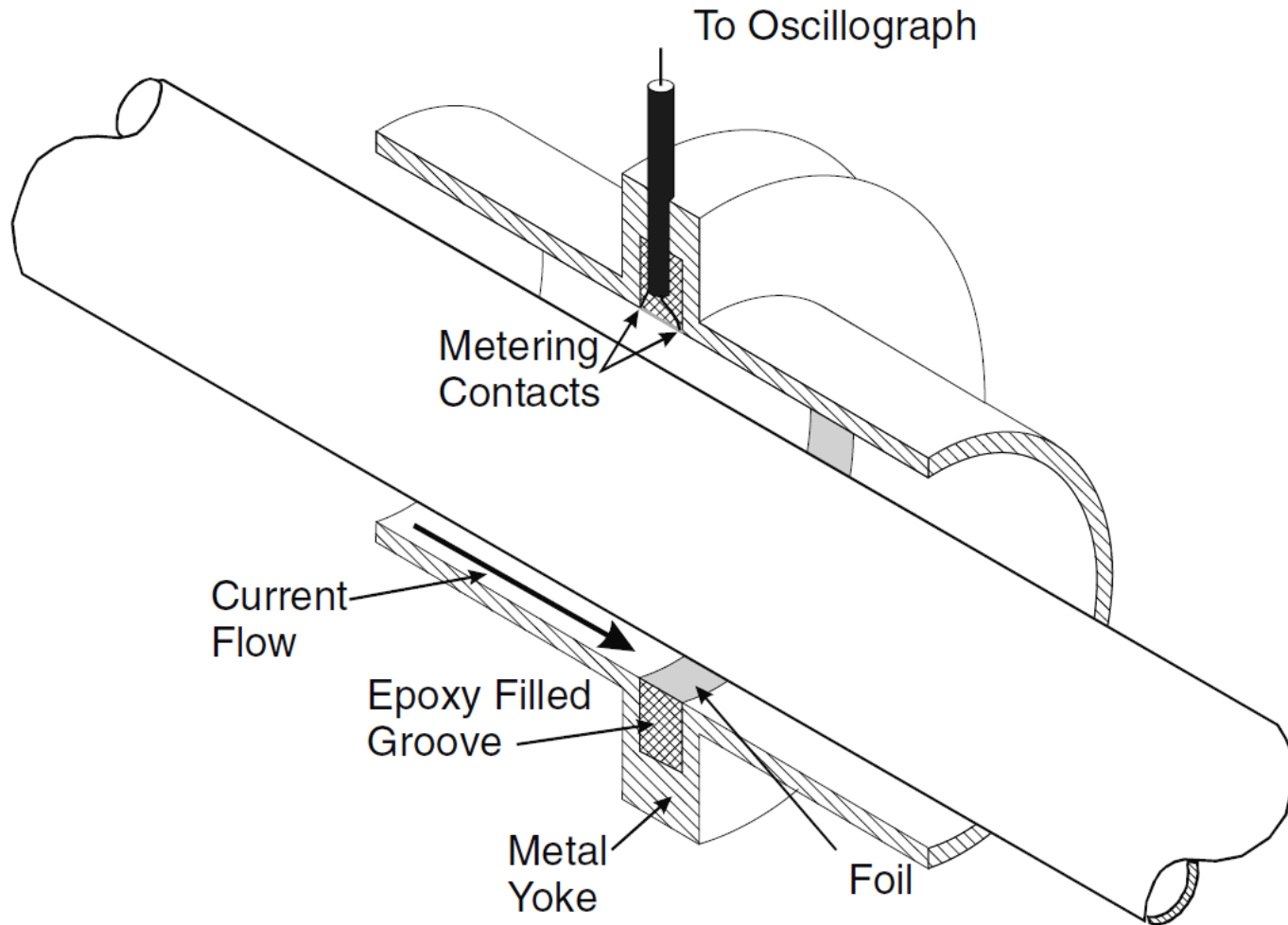

# Example of current and voltage monitor using B-dot and D-dot monitors

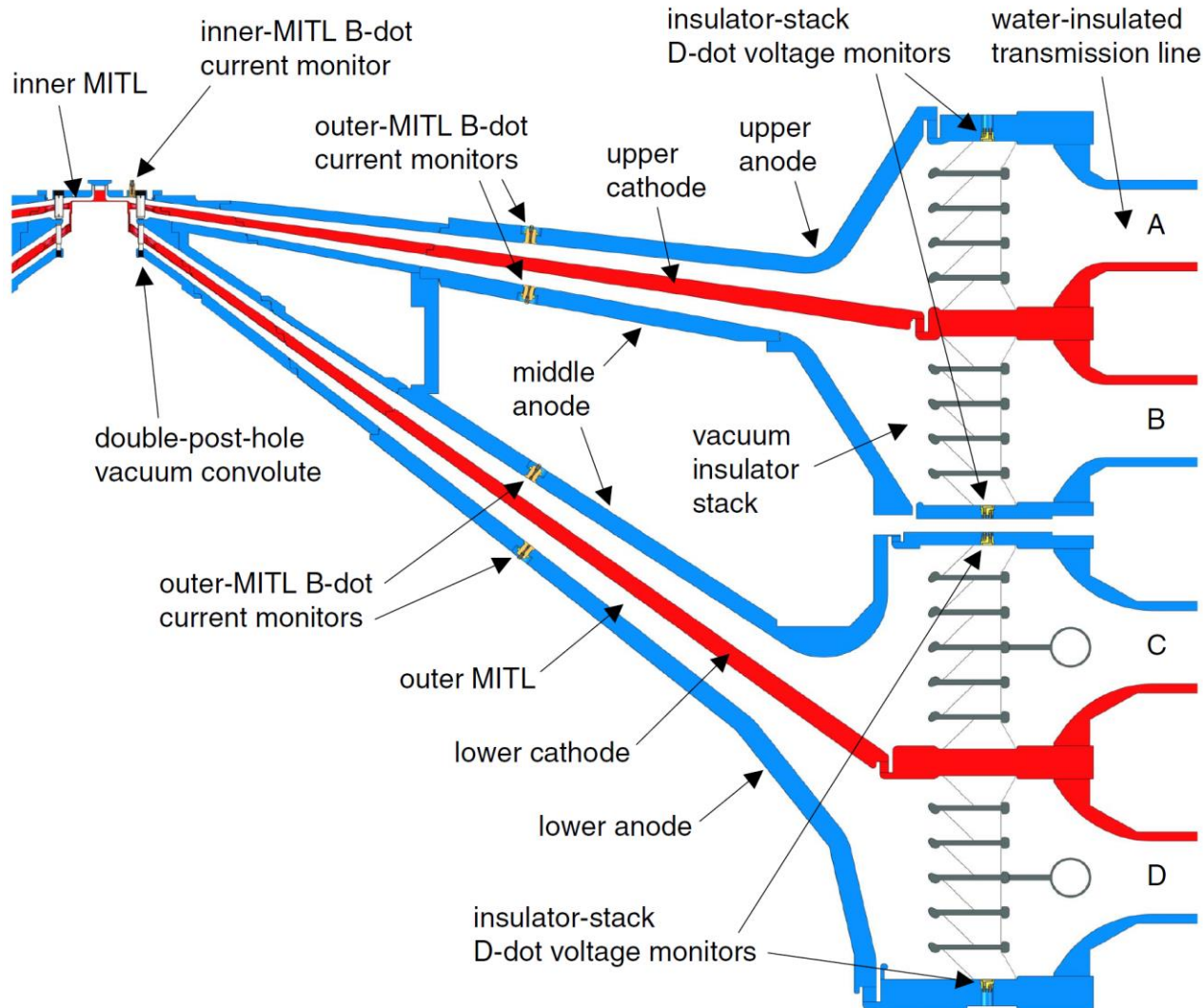

# Differential current monitors



- **Outer MITL B-dot current monitors:**

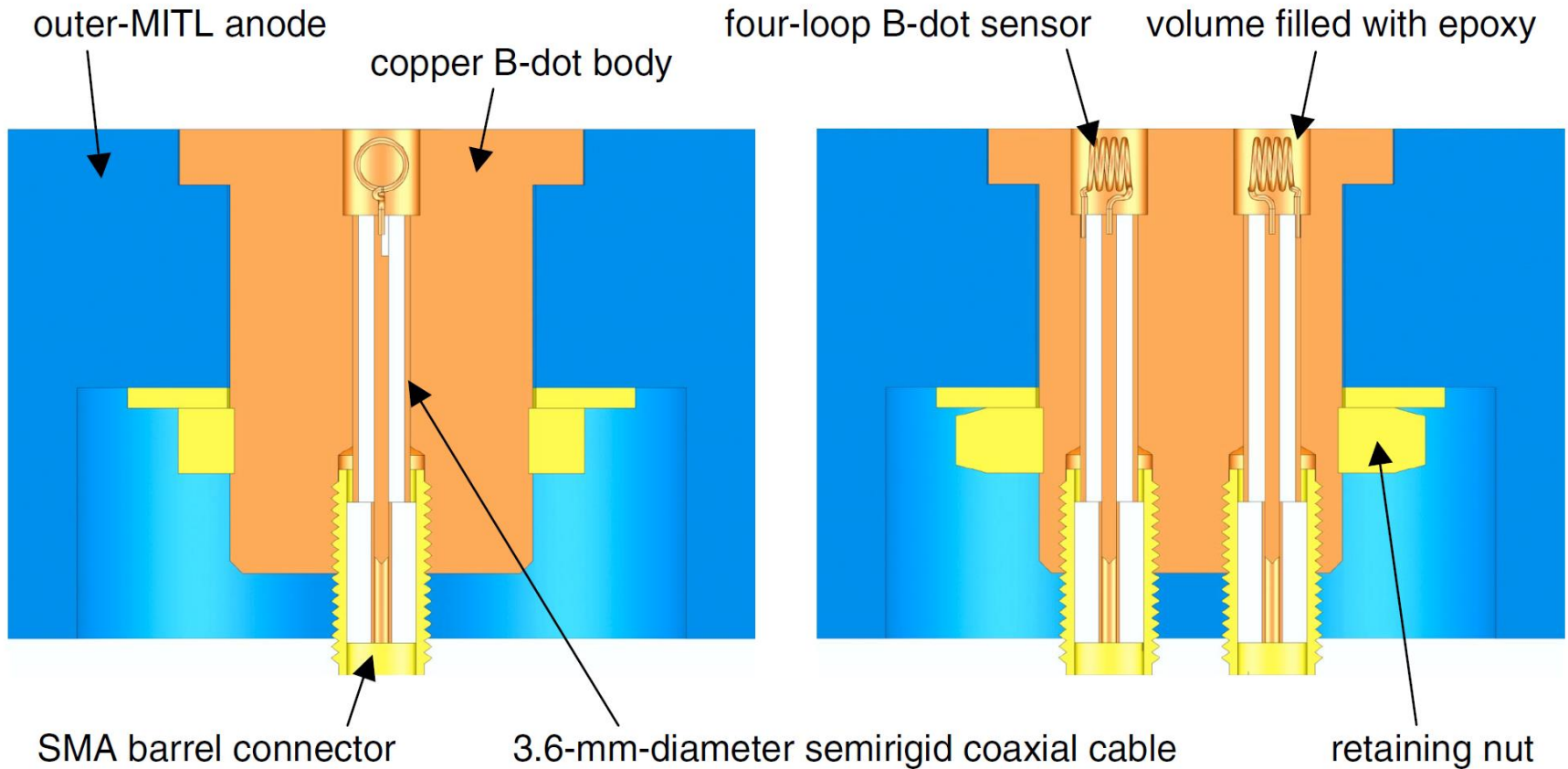



# Differential current monitors

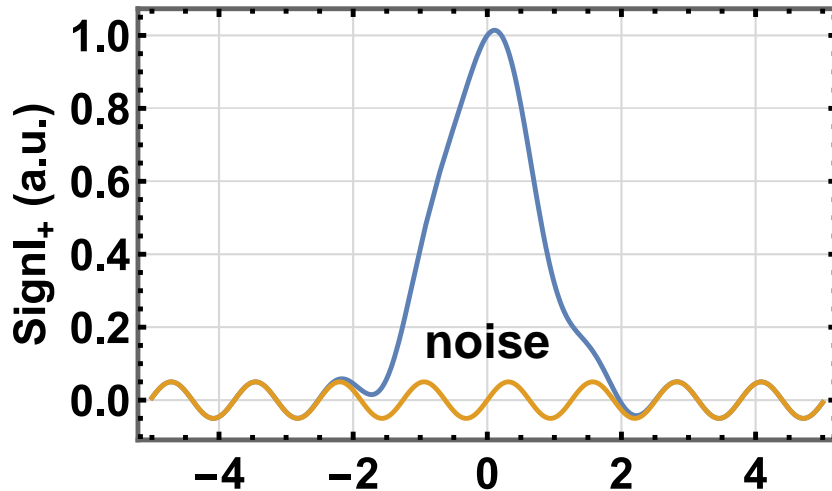

- The two B-dot sensors of each B-dot current monitor are designed to produce “opposite-polarity” signals for “common-mode-noise” rejection.

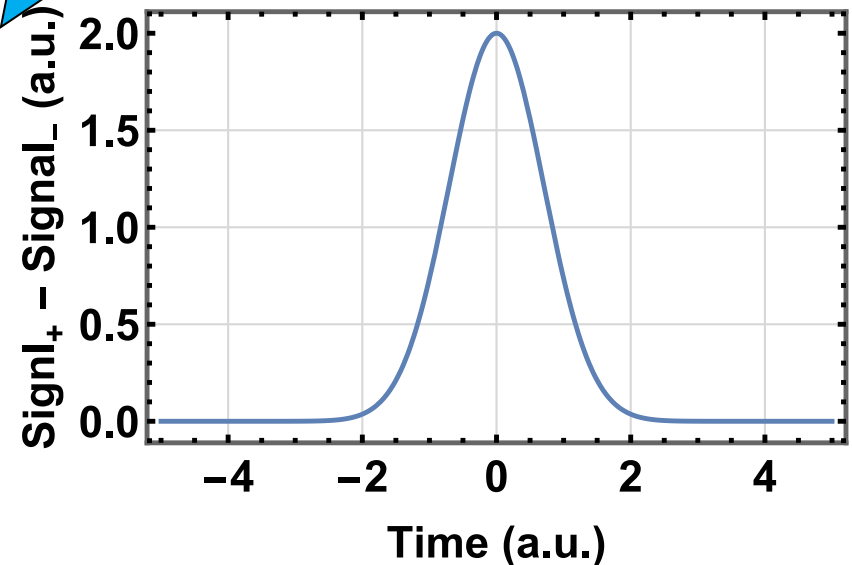
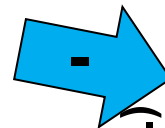
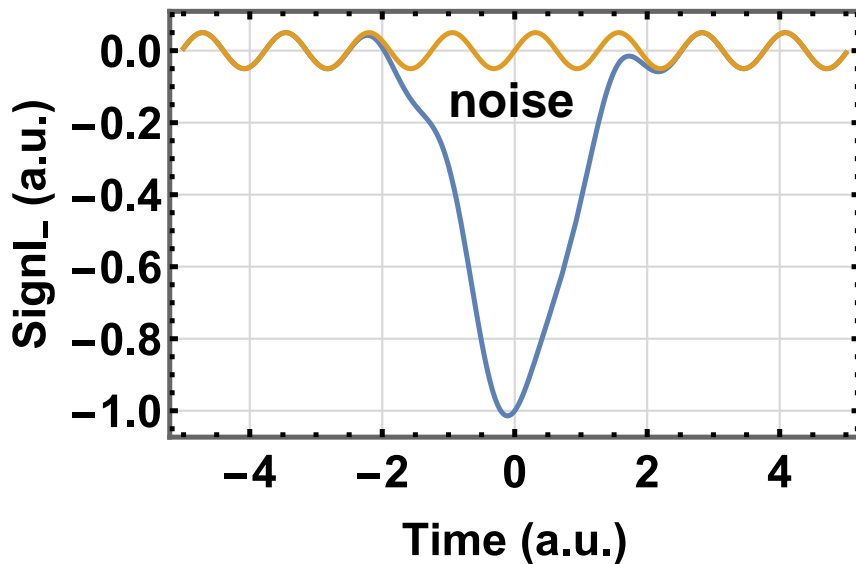

# Differential voltage monitor

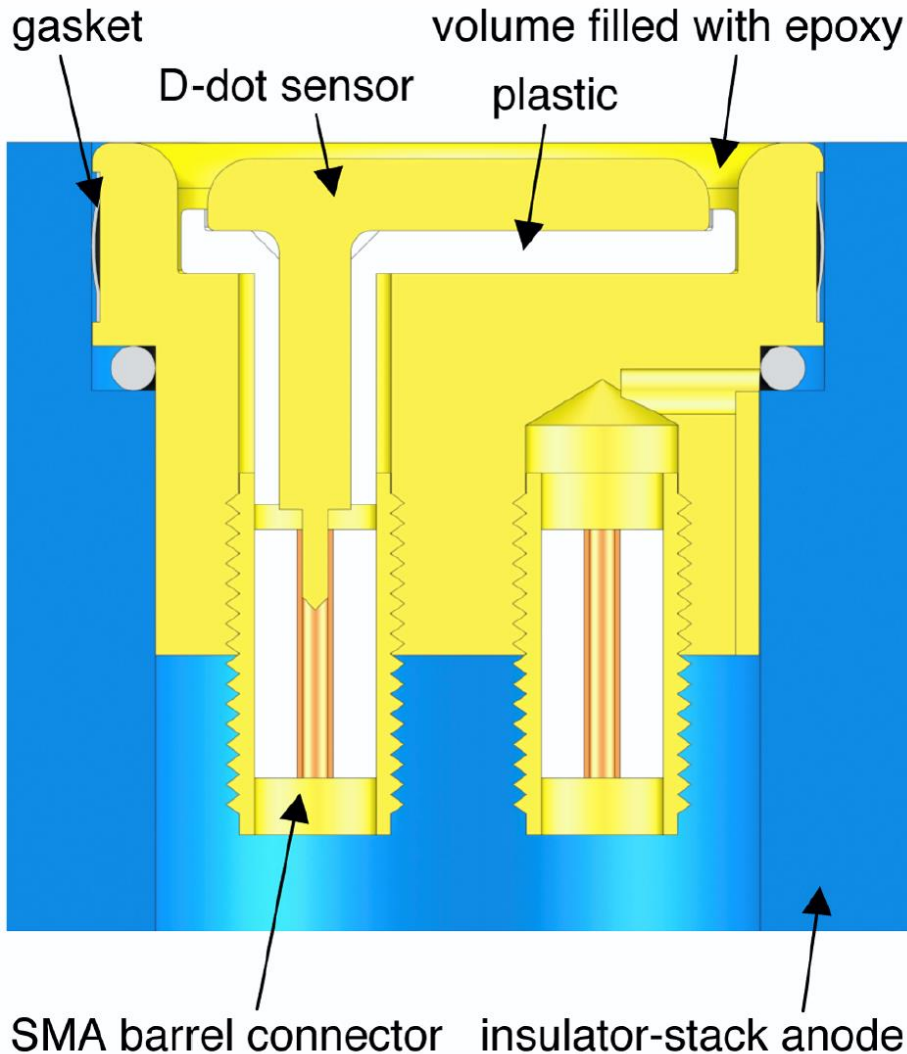

- **D-dot voltage monitor: the displacement-current monitor**
- **Opening-circuit termination for null measurements, i.e., common-mode noise reduction.**
- **Vacuum potted using stycast epoxy.**
- **Common-mode noise reduction is applied.**
- **Numerically cable compensated.**
- **Numerically integrated the signal.**

# Voltage divider using resistors

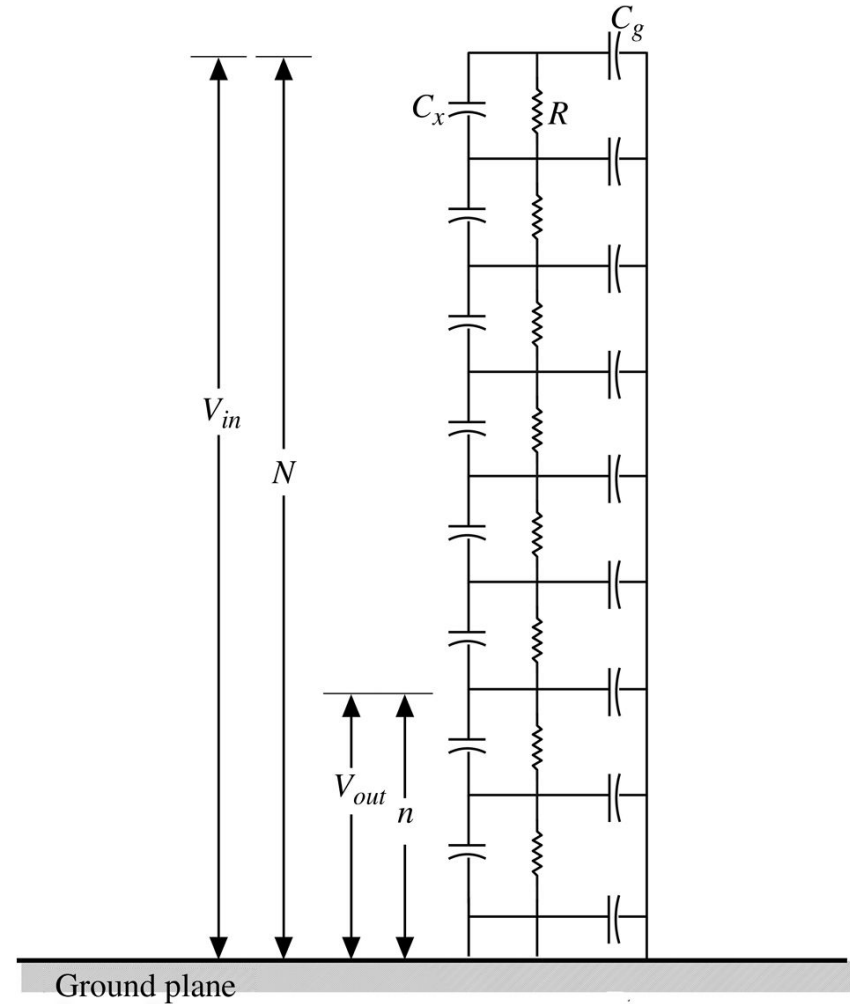
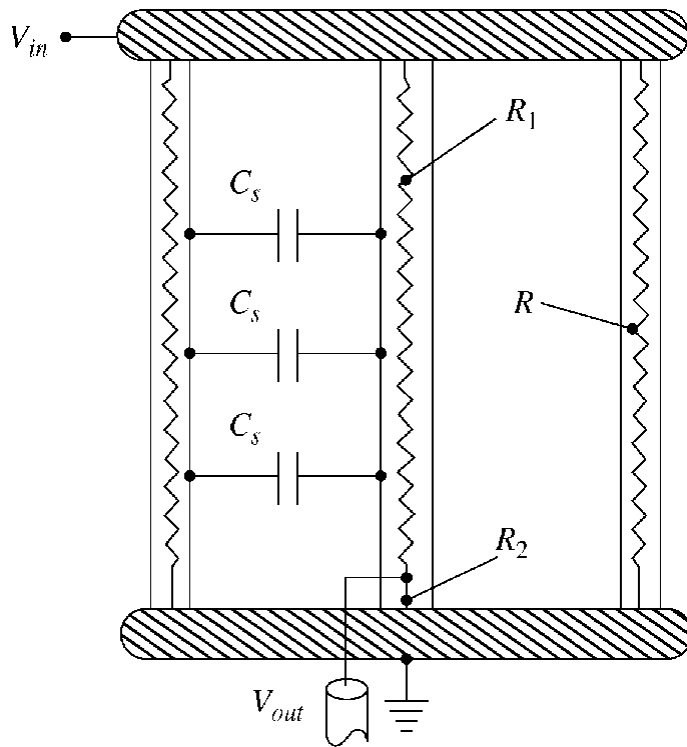
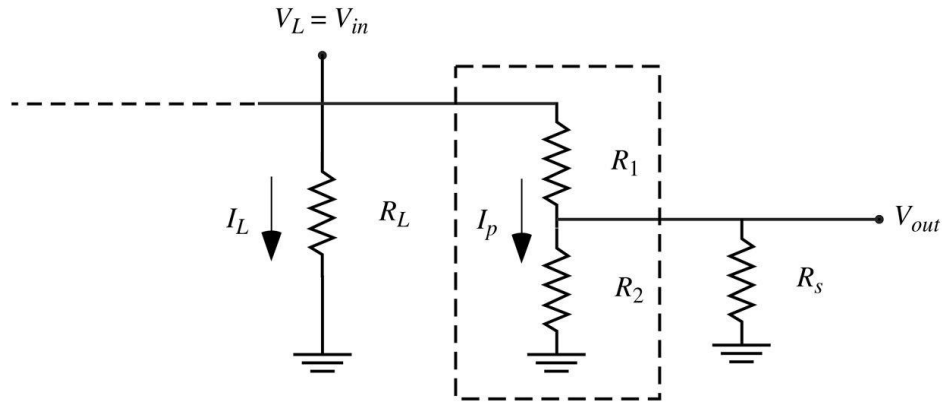

# Voltage divider liquid resistors and grading electrodes

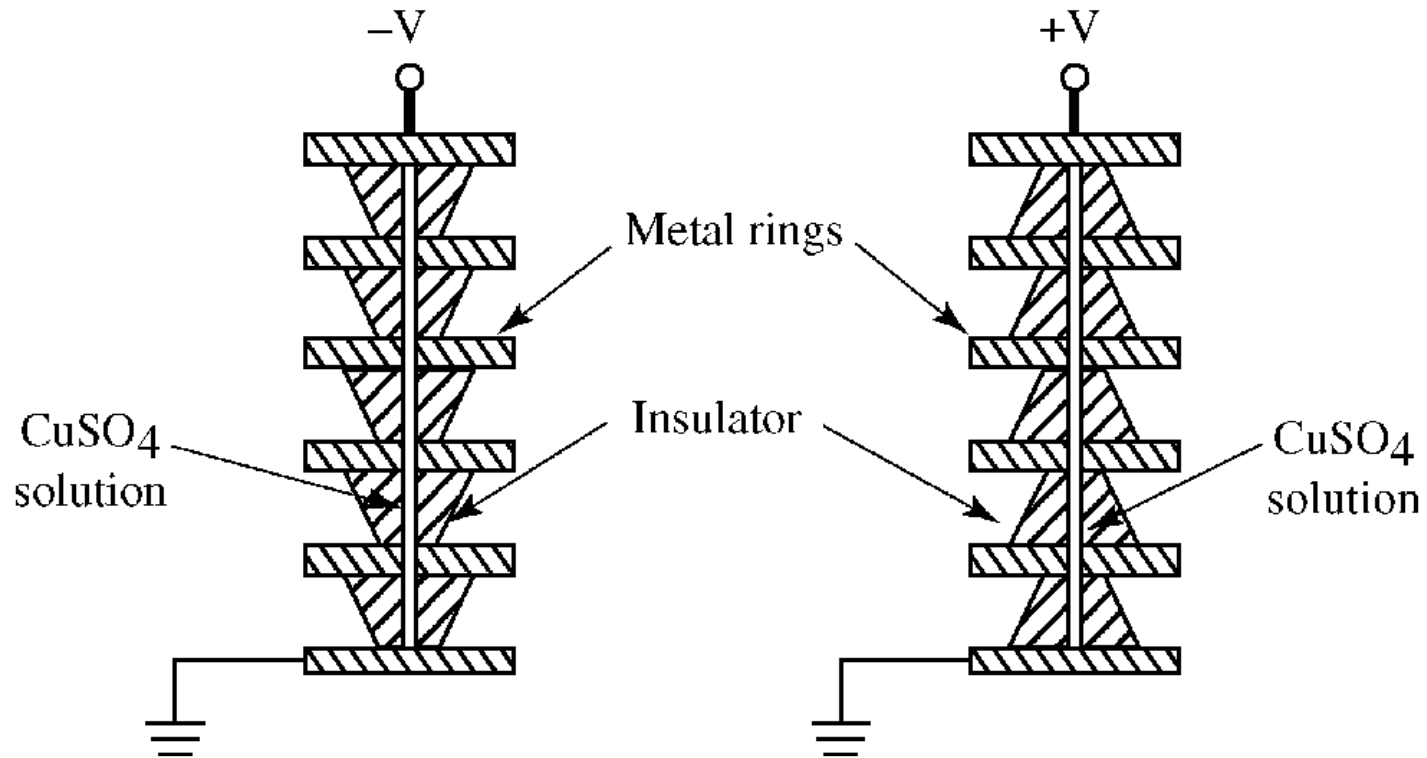

# Voltage divider on Mega Ampere Generator for Plasma Implosion Experiments (MAGPIE) facility

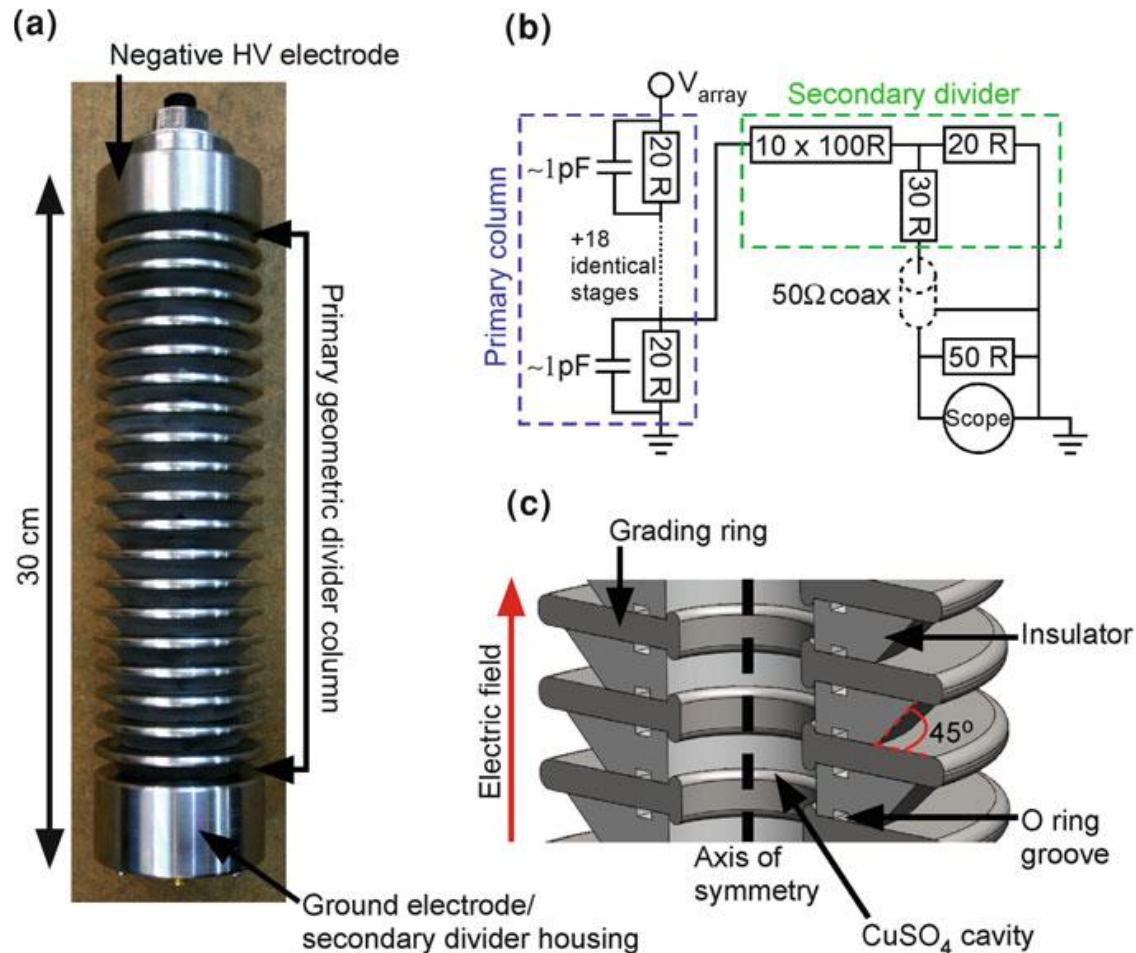

# Voltage divider on Mega Ampere Generator for Plasma Implosion Experiments (MAGPIE) facility

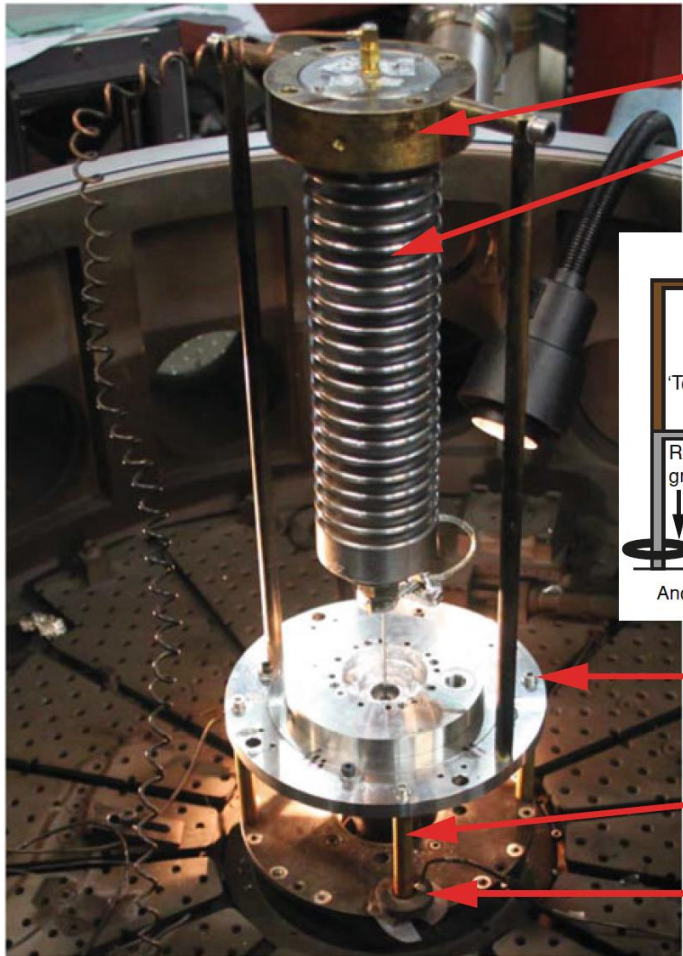

Probe mount  
Voltage divider

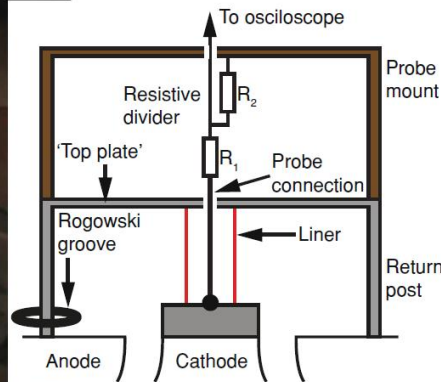

'Top plate'  
Return post  
Rogowski groove

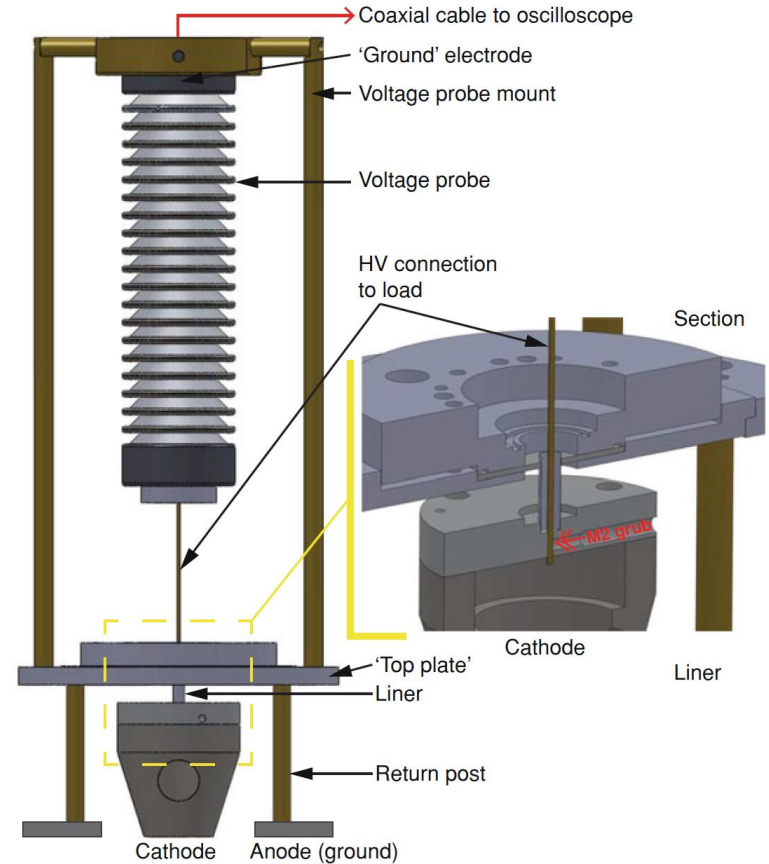



# Voltage divider on Mega Ampere Generator for Plasma Implosion Experiments (MAGPIE) facility

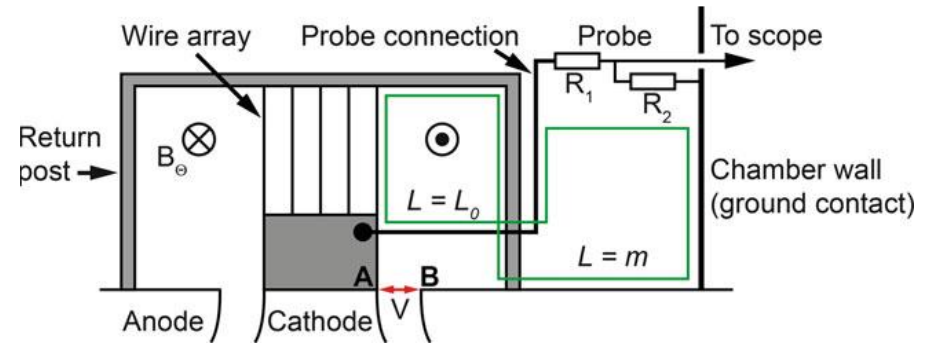
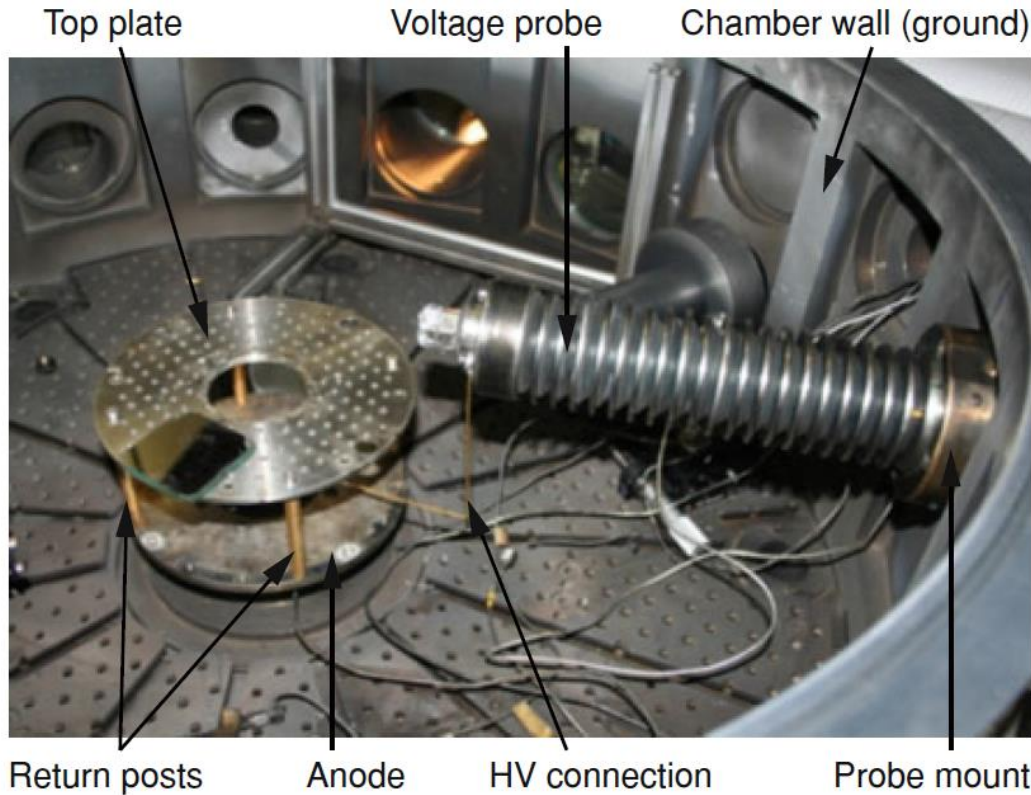

Guy C. Burdiak, Cylindrical Liner Z-pinches as Drivers for Converging Strong Shock Experiments

# Voltage divider using both resistors and capacitors

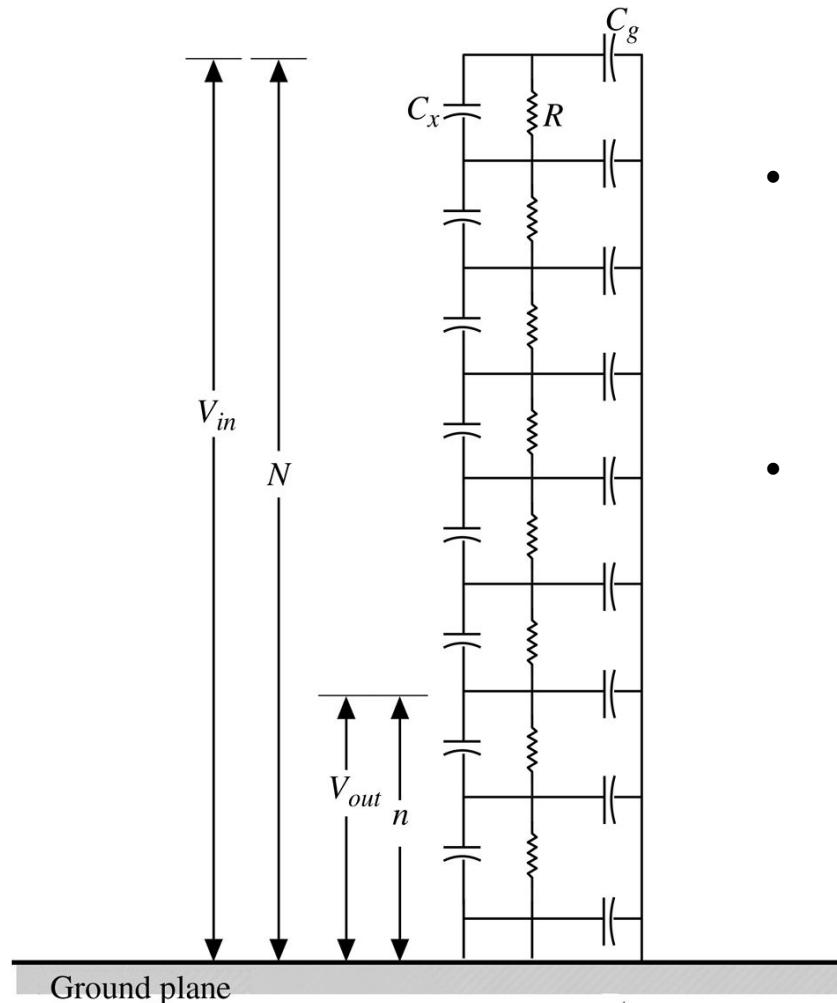

- **Low frequency:**

$$V_{out} = \frac{R_o}{\Sigma R_o} V_{in} = \frac{R_o}{NR_o} V_{in} = \frac{1}{N} V_{in}$$

- **High frequency:**

$$\begin{aligned} V_{out} &= \frac{\frac{C_o}{N-1}}{\frac{C_o}{N-1} + C_o} V_{in} = \frac{\frac{1}{N-1}}{\frac{1}{N-1} + 1} V_{in} \\ &= \frac{1}{1 + (N-1)} V_{in} = \frac{1}{N} V_{in} \end{aligned}$$

$$\text{or } V_{out} = \frac{1}{\Sigma \frac{1}{j\omega C_o}} V_{in} = \frac{1}{N} V_{in}$$



# Voltage divider on Mega Ampere Generator for Plasma Implosion Experiments (MAGPIE) facility

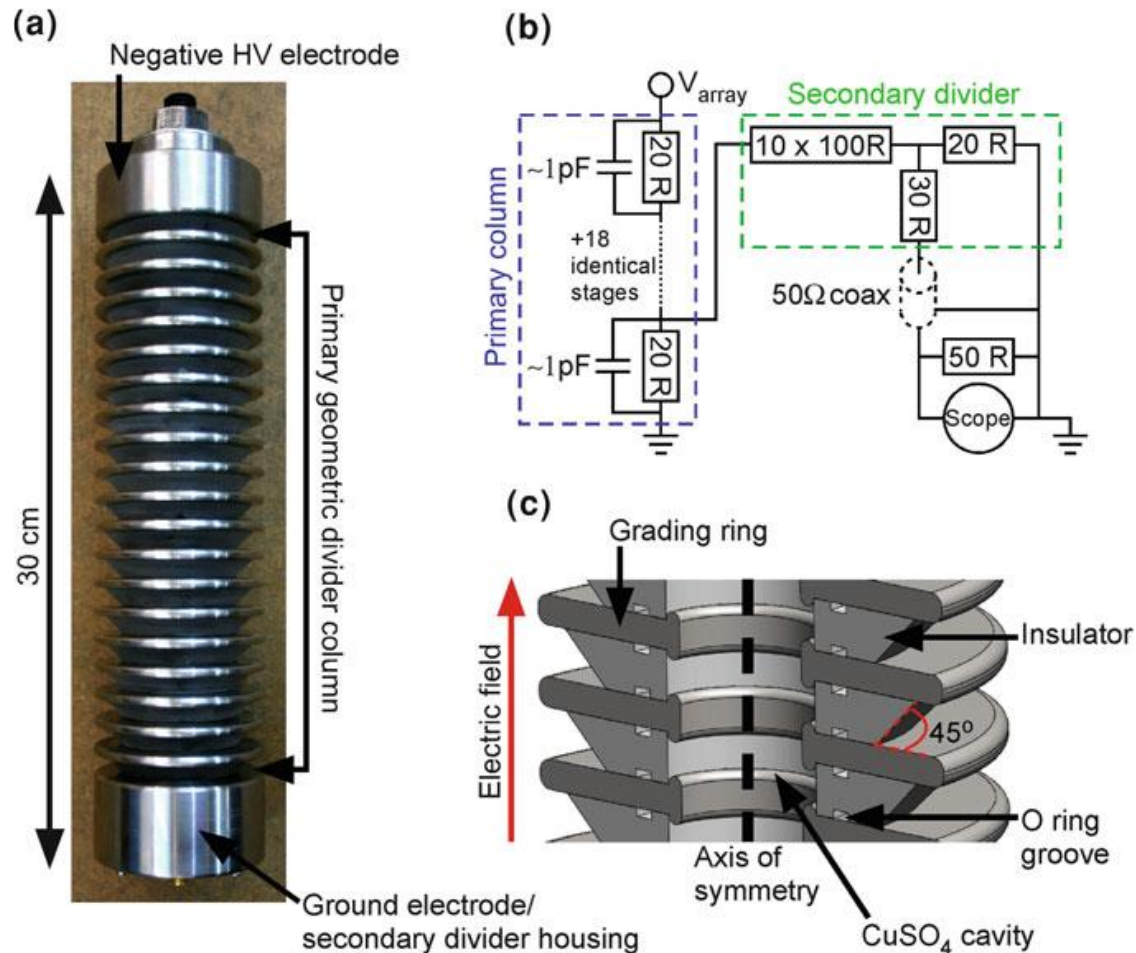

# Voltage divider on Mega Ampere Generator for Plasma Implosion Experiments (MAGPIE) facility

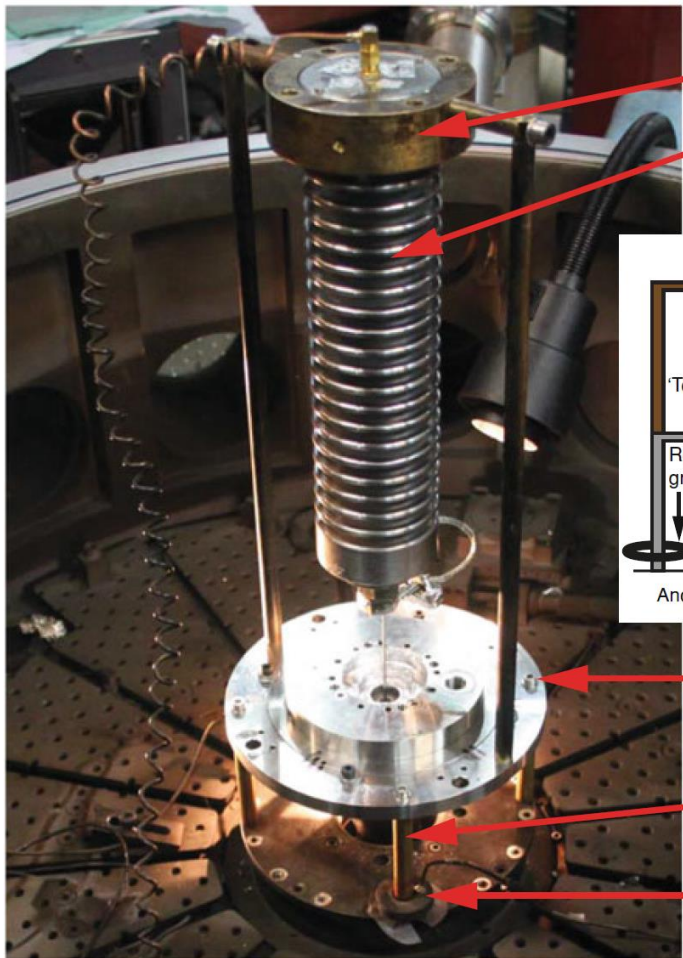

Probe mount  
Voltage divider

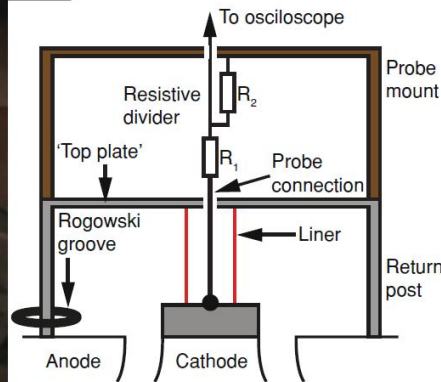

'Top plate'  
Return post  
Rogowski groove

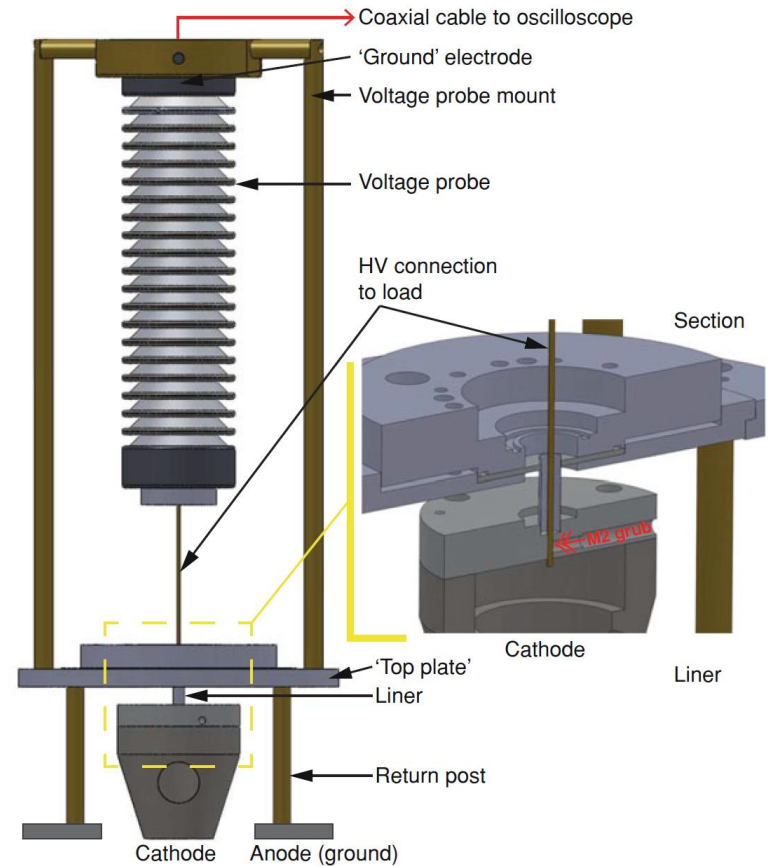

# Voltage divider on Mega Ampere Generator for Plasma Implosion Experiments (MAGPIE) facility

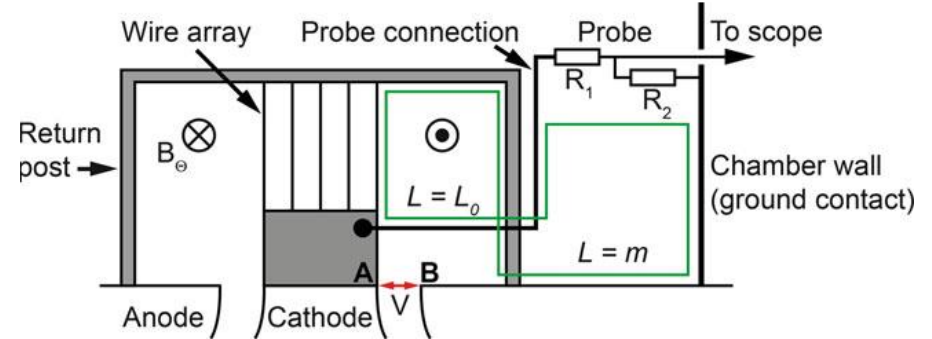
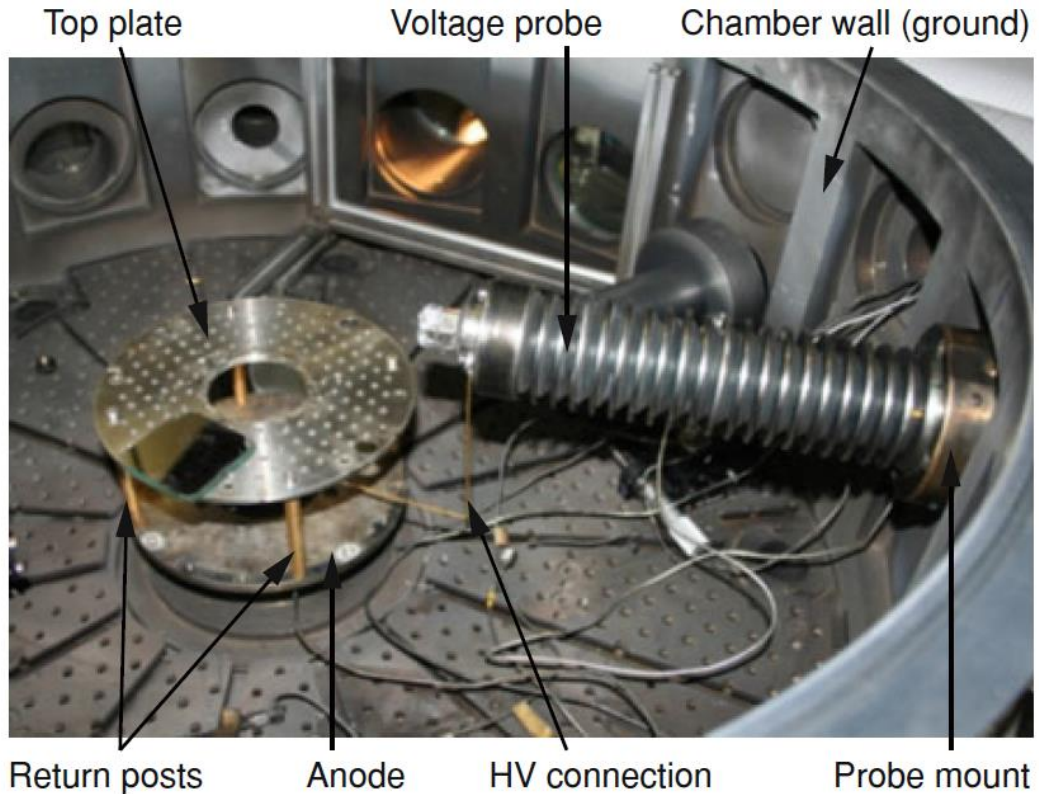

Guy C. Burdiak, Cylindrical Liner Z-pinches as Drivers for Converging Strong Shock Experiments

# Voltage divider using both resistors and capacitors

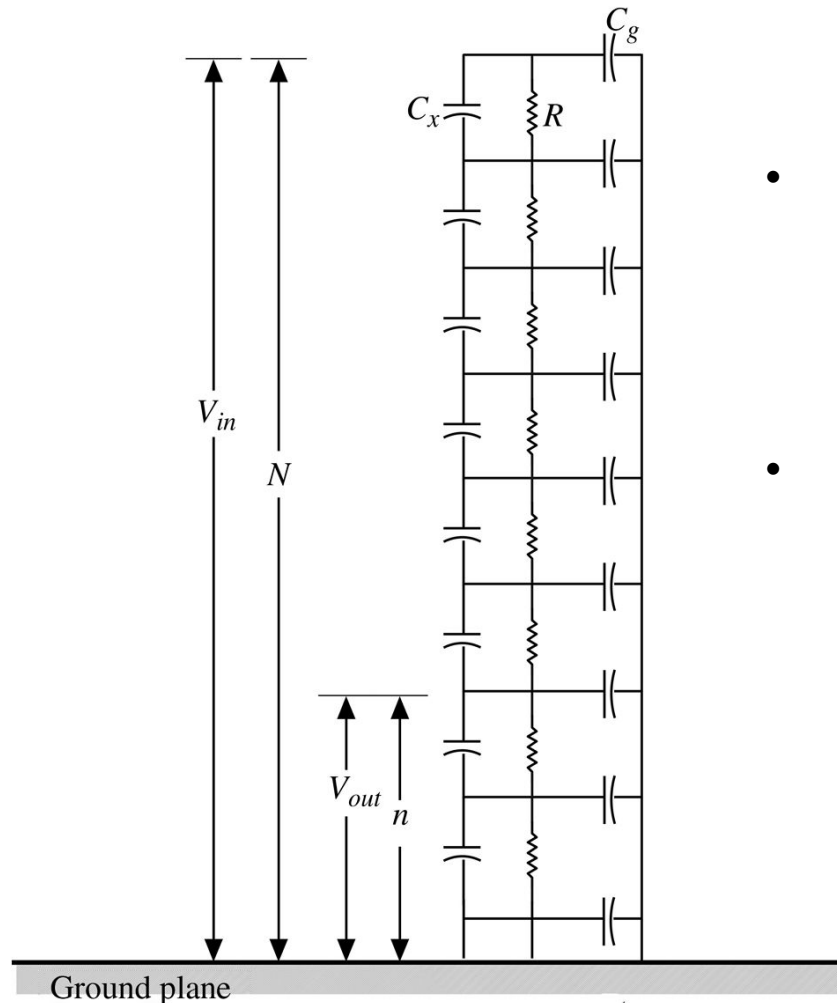

- **Low frequency:**

$$V_{out} = \frac{R_o}{\Sigma R_o} V_{in} = \frac{R_o}{NR_o} V_{in} = \frac{1}{N} V_{in}$$

- **High frequency:**

$$\begin{aligned} V_{out} &= \frac{\frac{C_o}{N-1}}{\frac{C_o}{N-1} + C_o} V_{in} = \frac{\frac{1}{N-1}}{\frac{1}{N-1} + 1} V_{in} \\ &= \frac{1}{1 + (N-1)} V_{in} = \frac{1}{N} V_{in} \end{aligned}$$

$$\text{or } V_{out} = \frac{1}{\Sigma \frac{1}{j\omega C_o}} V_{in} = \frac{1}{N} V_{in}$$

# Outlines

---



- Power and voltage adding
  - Marx generator
  - LC generator
  - Line pulse transformers
  - Induction voltage adder (IVA)
  - Linear induction accelerator (LIA)
  - Linear transformer driver (LTD)
- Diagnostics
  - Voltage measurement
  - Current measurement
- **Applications of pulsed-power system**



# Karlsruhe Light Ion Facility (KALIF)

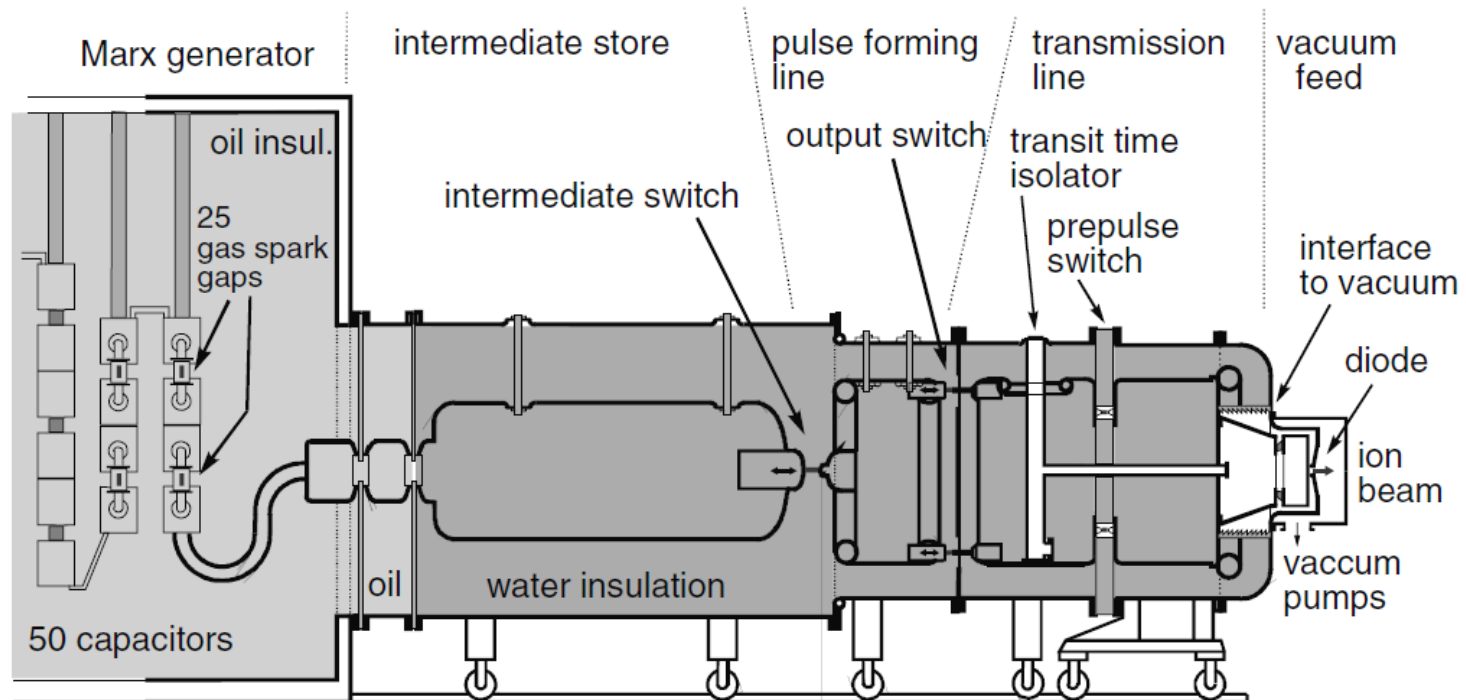

**Fig. 8.1.** Schematic illustration of the 1.5 TW pulse generator KALIF. The data for the pulse at the vacuum interface are: power = 1.5 TW, voltage = 1.7 MV, pulse duration = 50 ns, pulse energy = 75 kJ, electrical efficiency = 30%

# Magpie at Imperial college

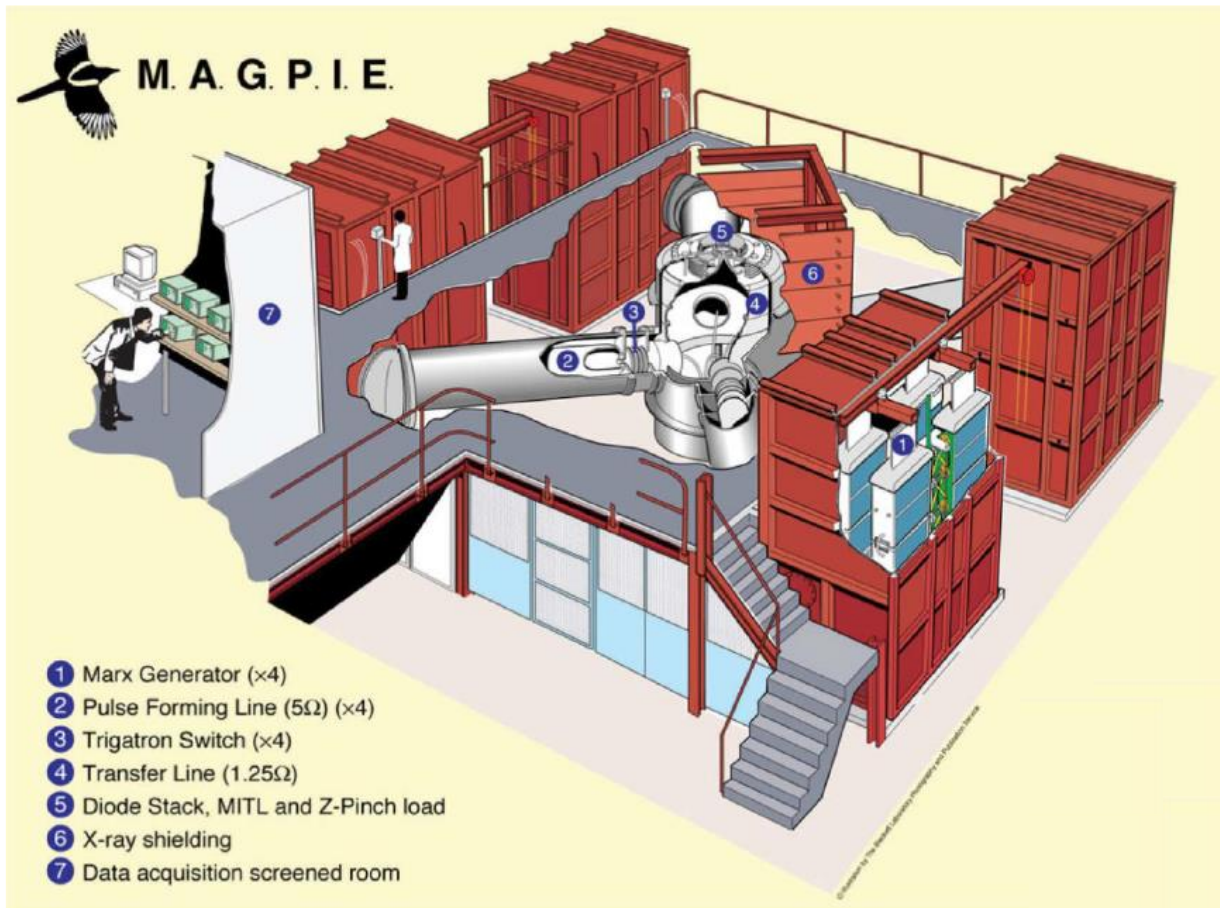

$E = 86 \text{ kJ}$

$I = 1 \text{ MA}$

$T_{\text{rise}} = 250 \text{ ns}$

# Cobra at Cornell University

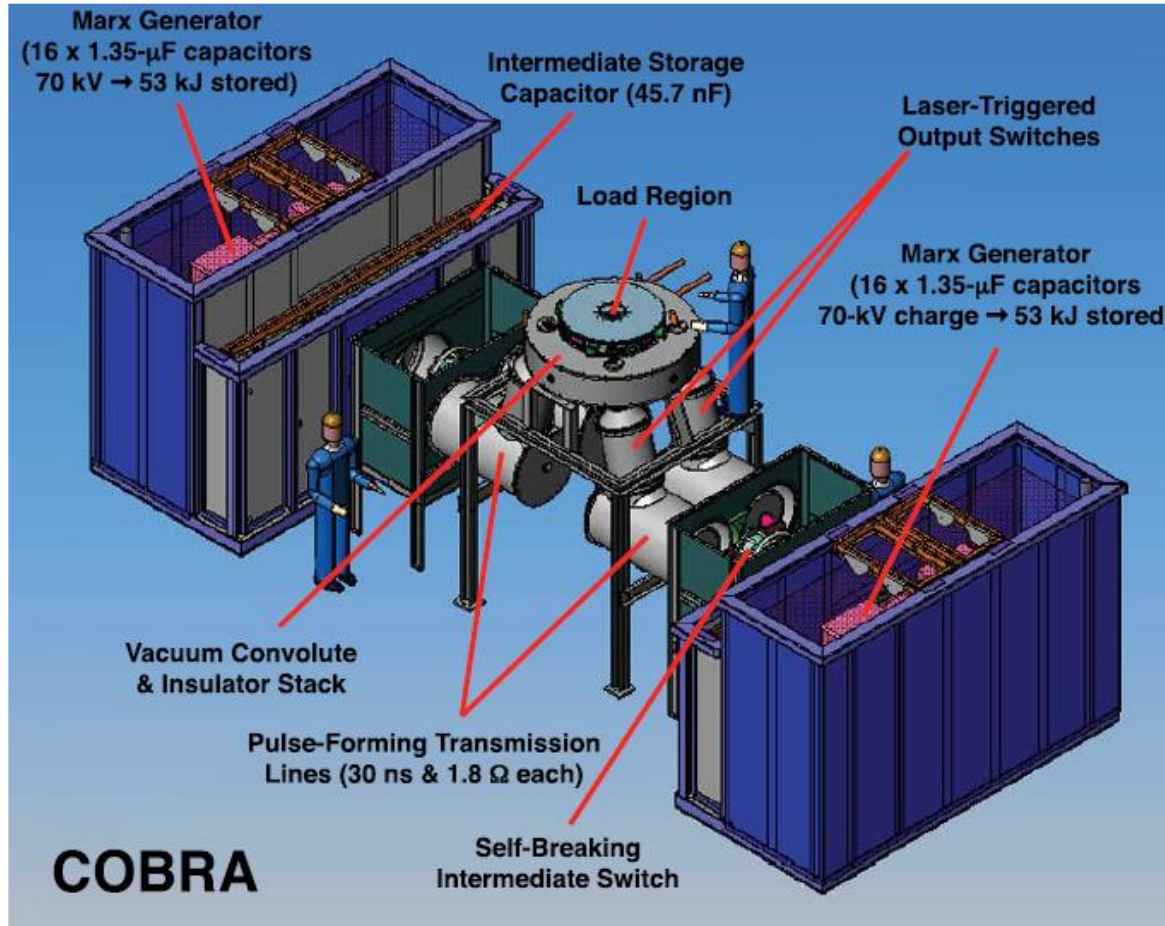

$$E = 105 \text{ kJ}$$

$$I = 1 \text{ MA}$$

$$T_{\text{rise}} = 100 \text{ ns}$$



# Zebra at University of Nevada, Reno

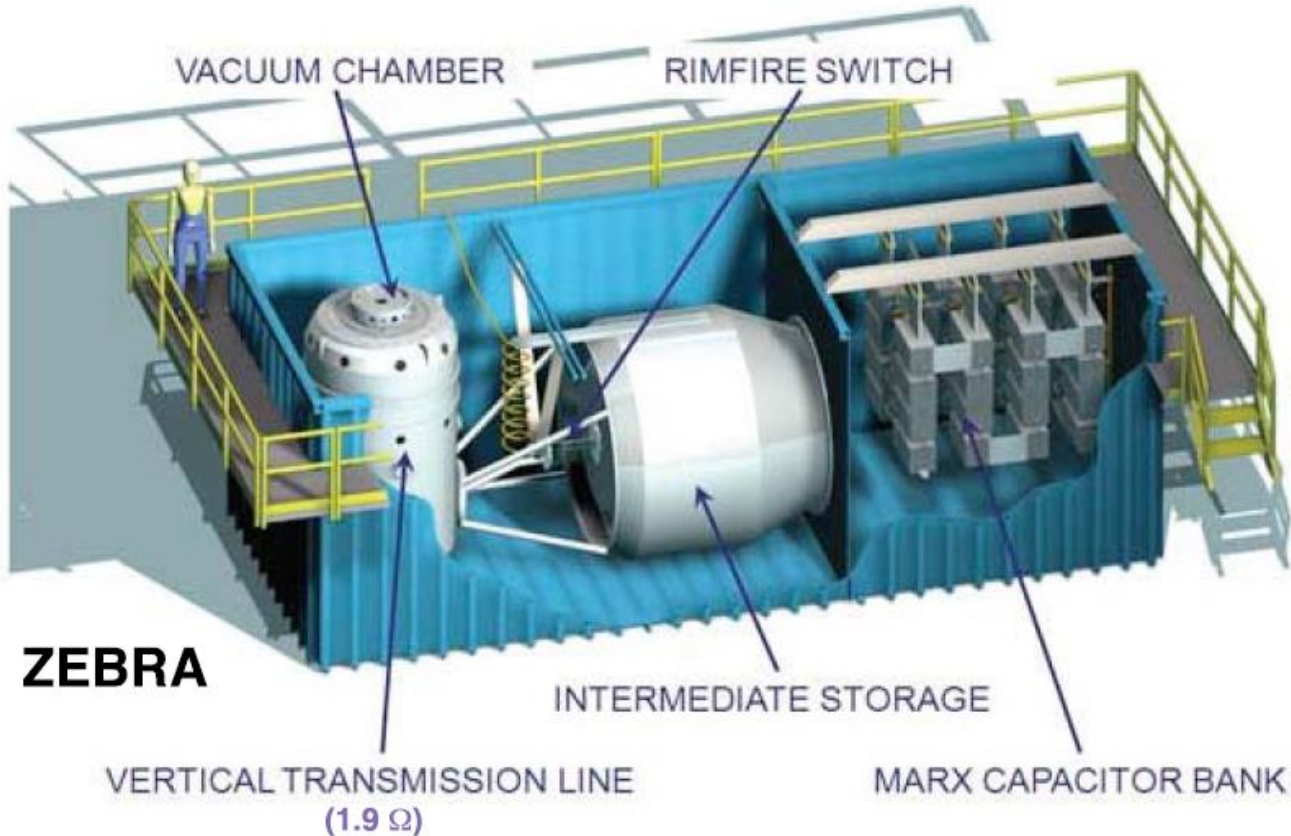

**$E = 200 \text{ kJ}$**   
 **$I = 1 \text{ MA}$**   
 **$T_{\text{rise}} = 100 \text{ ns}$**

# Maize LTD at University of Michigan



MAIZE (LTD)

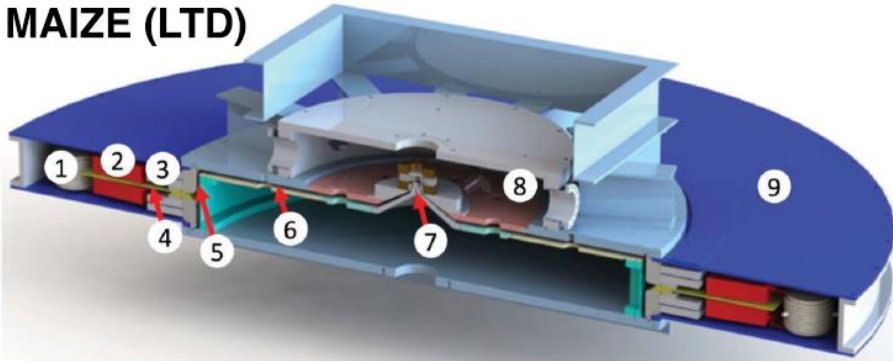

$E = 16 \text{ kJ}$

$I = 1 \text{ MA}$

$T_{\text{rise}} = 100 \text{ ns}$



# Hades at University of Rochester

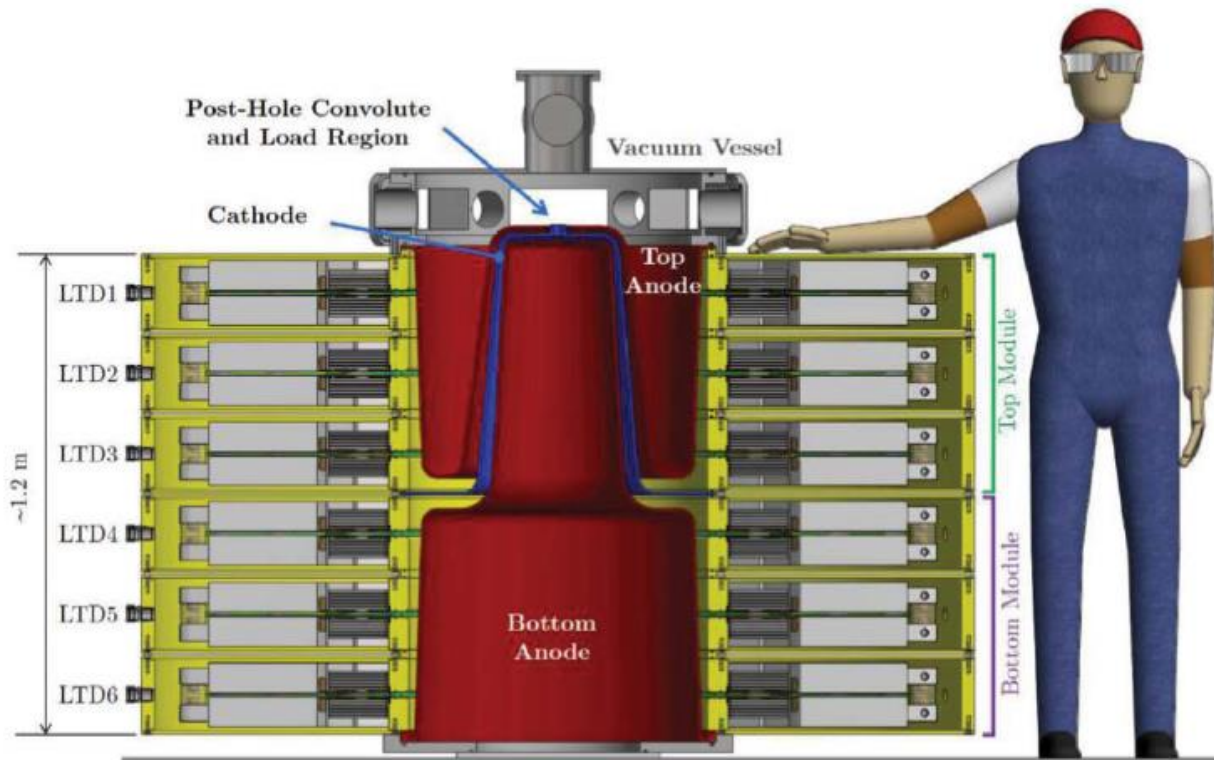

$E = 75 \text{ kJ}$   
 $I = 1 \text{ MA}$   
 $T_{\text{rise}} = 125 \text{ ns}$

# Particle Beam Fusion Accelerator (PBFA 2) and the Z-Machine

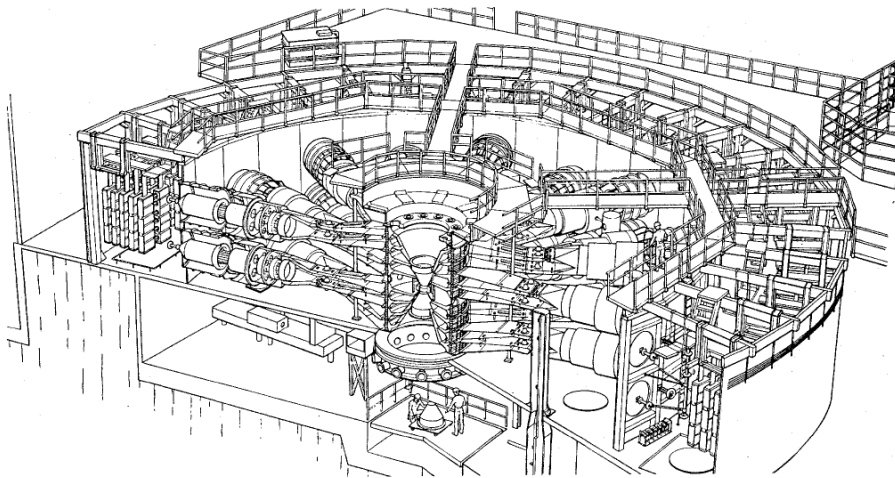

Fig. 8.2. Perspective drawing of the multimodular generator PBFA 2

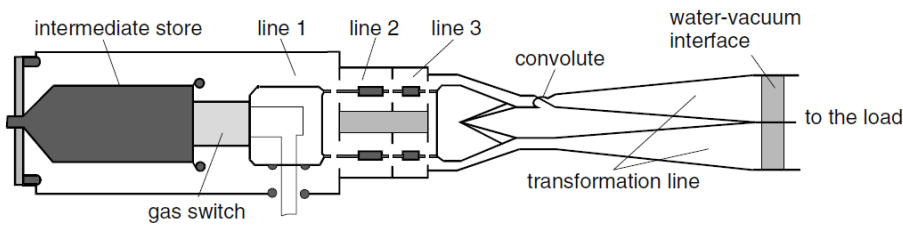

Fig. 8.3. Pulse-forming network of a single module of the PBFA 2 device

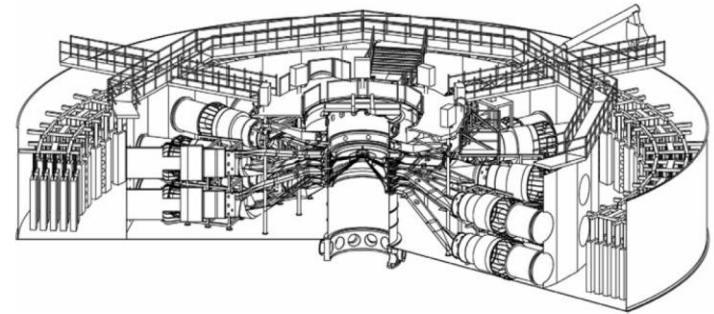

Fig. 8.4. Schematic illustration of the Z-Machine for driving Z-pinch, located at Sandia National Laboratory

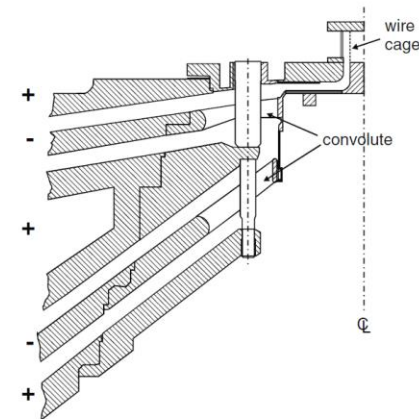
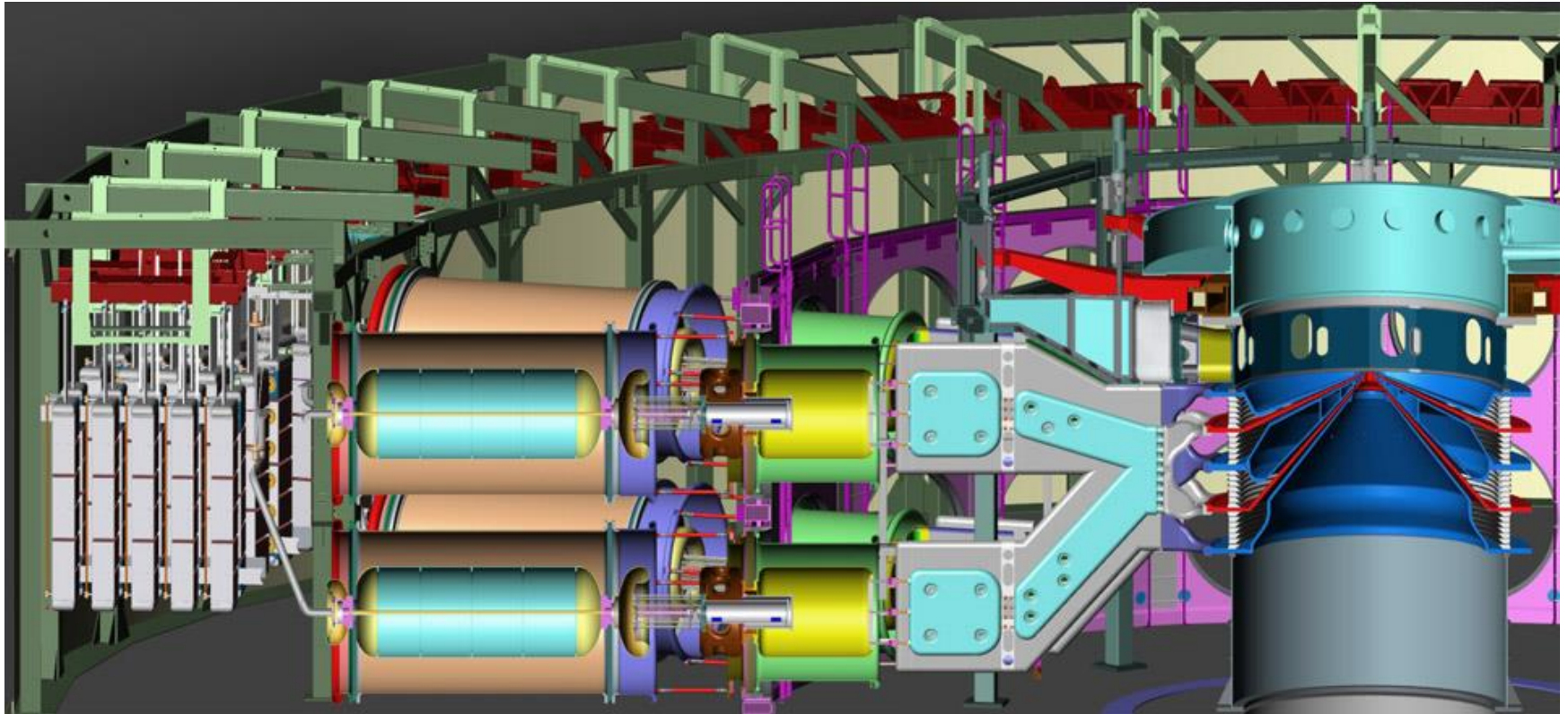

Fig. 8.5. Post-hole convolute in the Z-Machine



# Sandia's Z machine is the world's most powerful and efficient laboratory radiation source



- **Stored energy: 20 MJ**
- **Marx charge voltage: 85 kV**
- **Peak electrical power: 85 TW**
- **Peak current: 26 MA**
- **Rise time: 100 ns**
- **Peak X-ray emissions: 350 TW**
- **Peak X-ray output: 2.7 MJ**

# Z pulsed-power accelerator: 20 MA, 3MV, 55TW

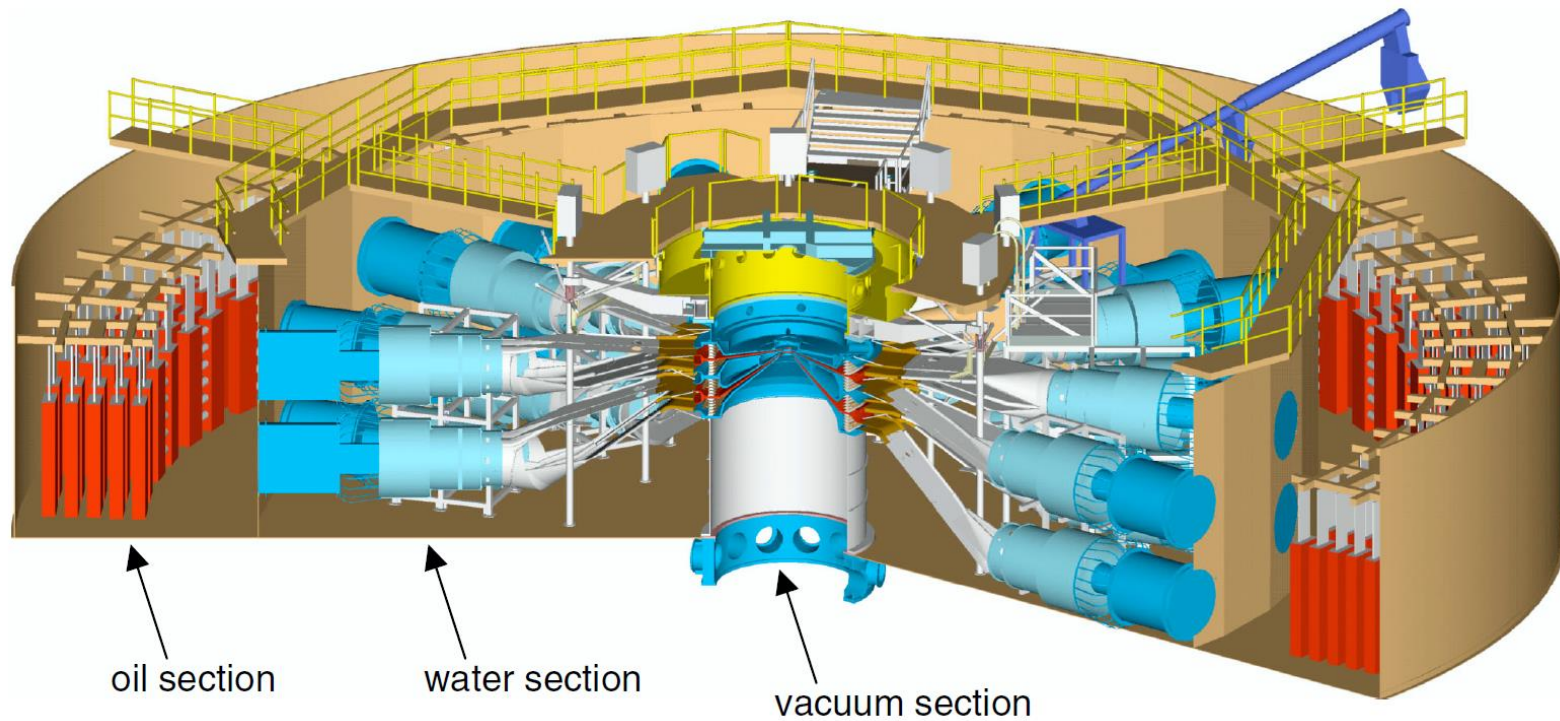

# Self-magnetically insulated vacuum transmission lines (MITLs)

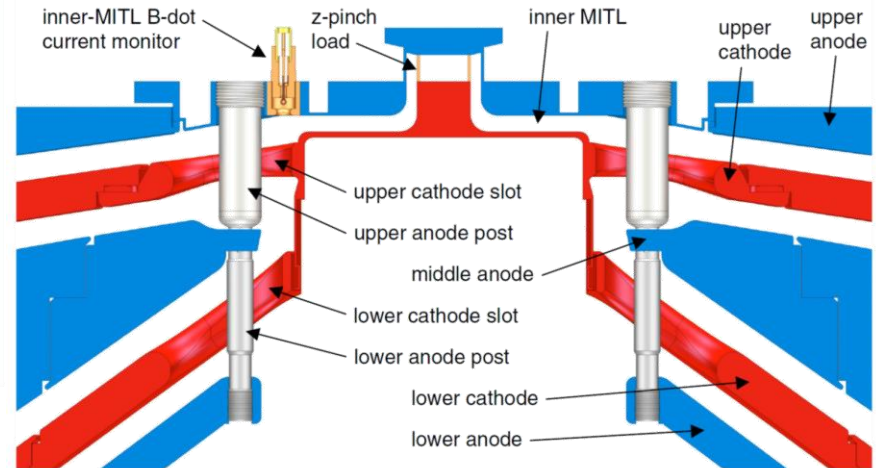
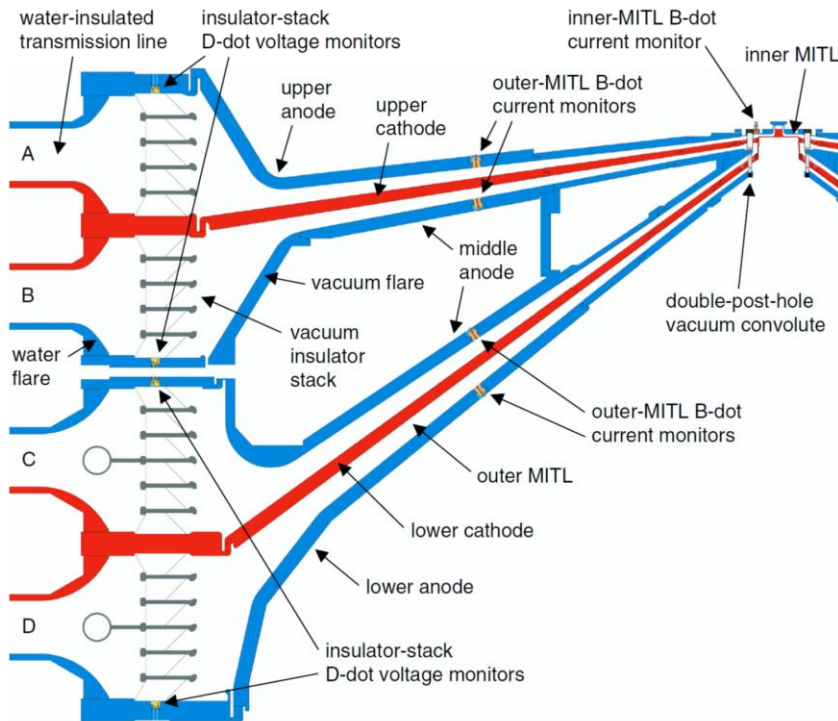



# Z machine

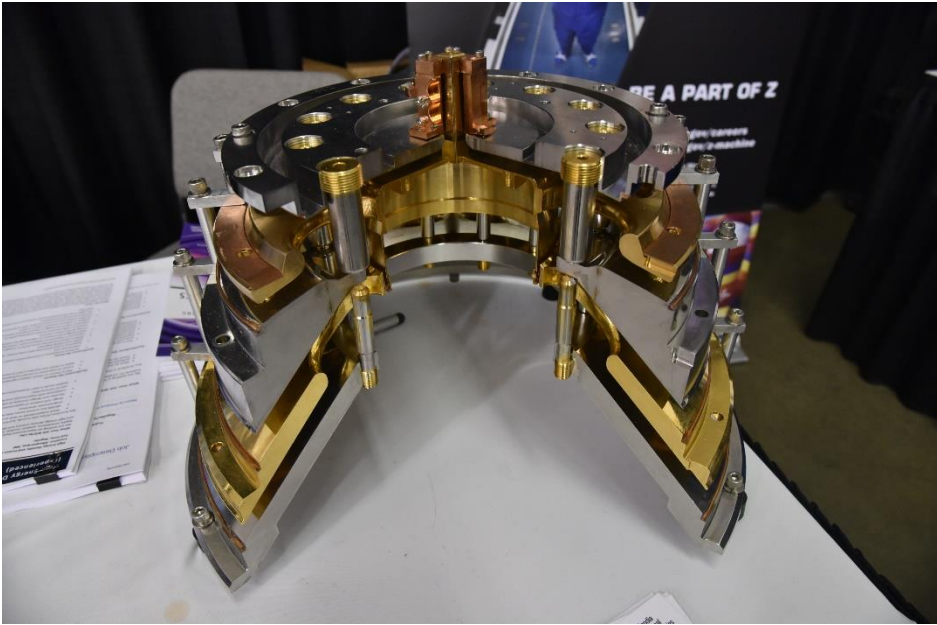



# Z machine

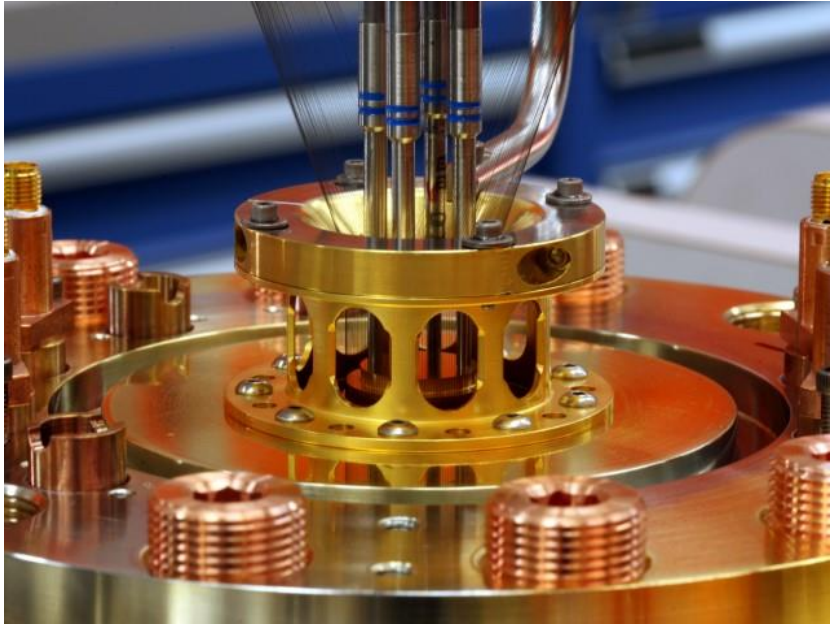
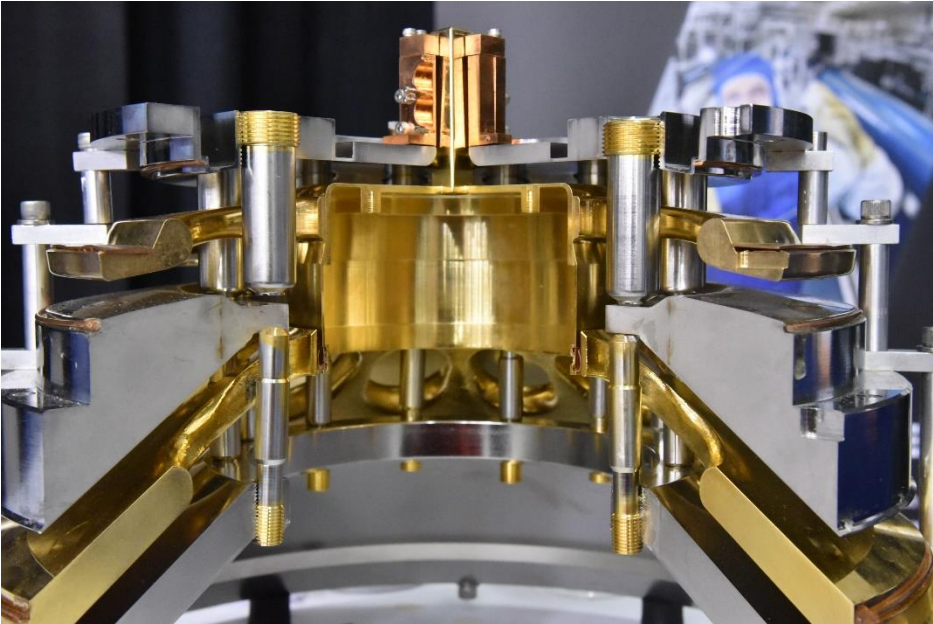



# Z machine discharge

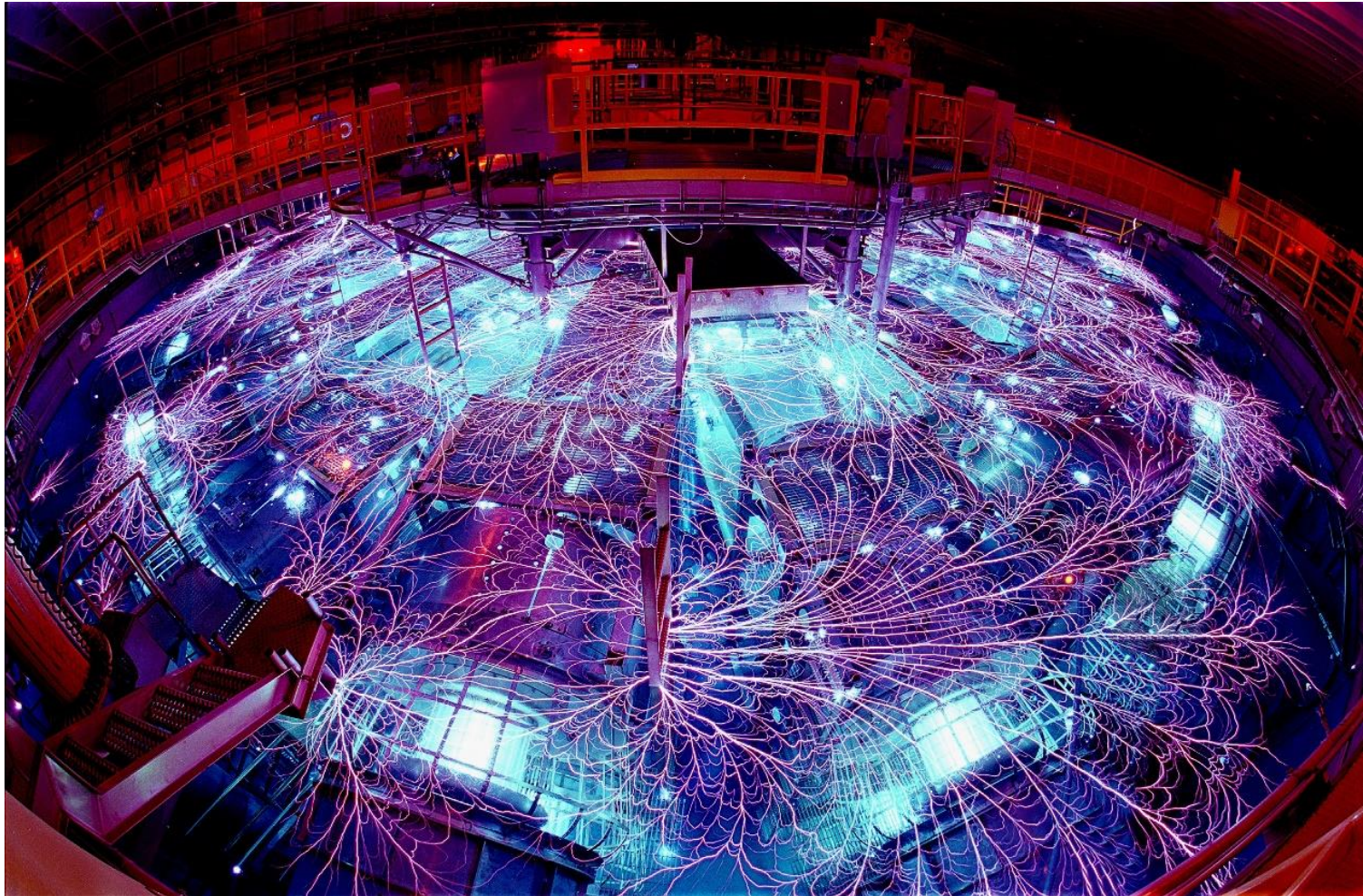



# Before and after shots



- Before shots

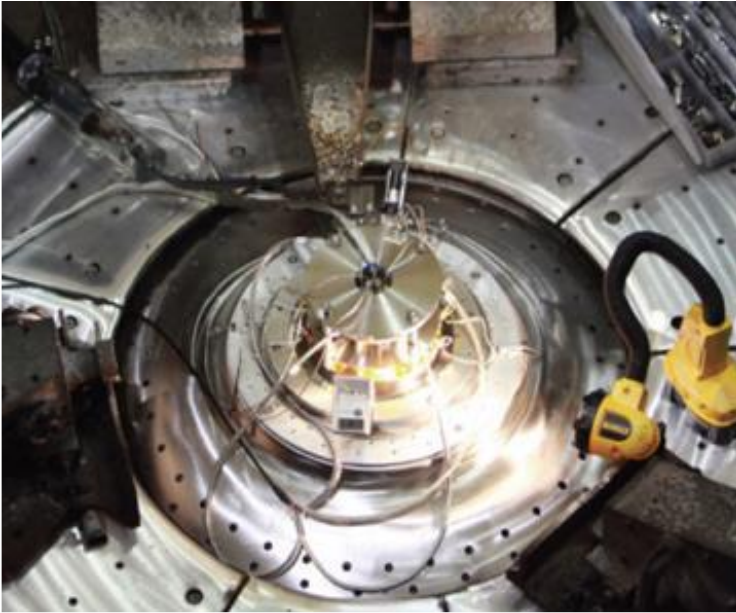

- After shots



SAND2017-0900PE\_The sandia z machine - an overview of the world's most powerful pulsed power facility.pdf

# The “iron group” of isotopes are the most tightly bound

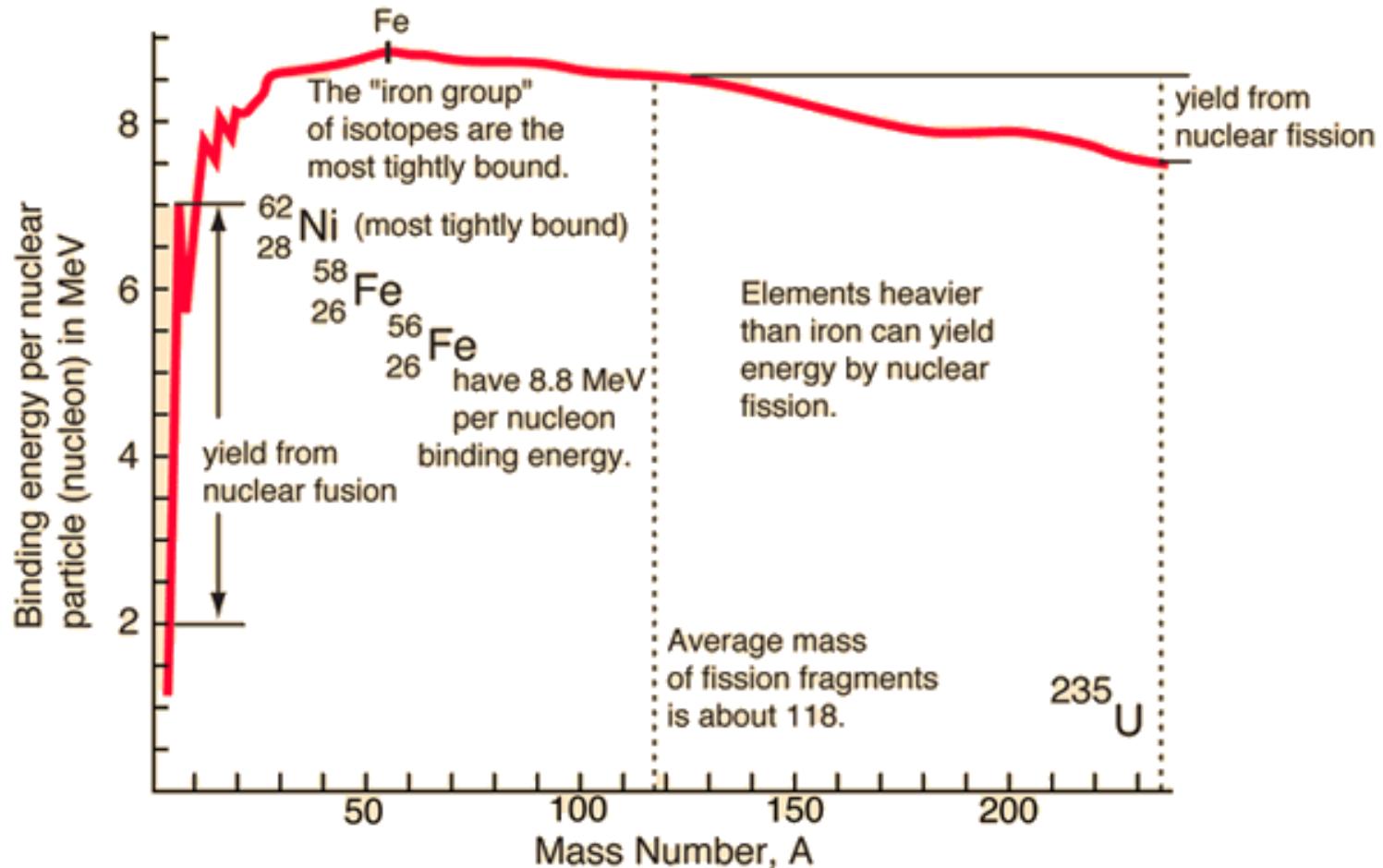

# Fusion is much harder than fission



- **Fission:**  $n + {}_{92}^{235}\text{U} \rightarrow {}_{92}^{236}\text{U} \rightarrow {}_{56}^{144}\text{Ba} + {}_{36}^{89}\text{Kr} + 3n + 177\text{ MeV}$
- **Fusion:**  $D + T \rightarrow \text{He}^4 (3.5\text{ MeV}) + n (14.1\text{ MeV})$

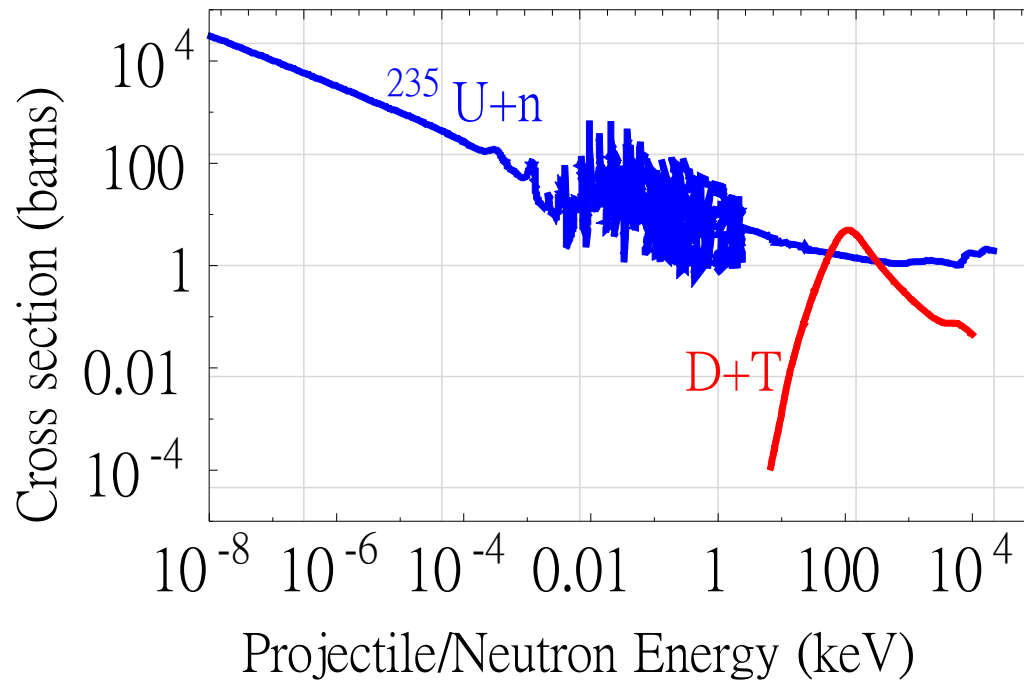

# The fusion process

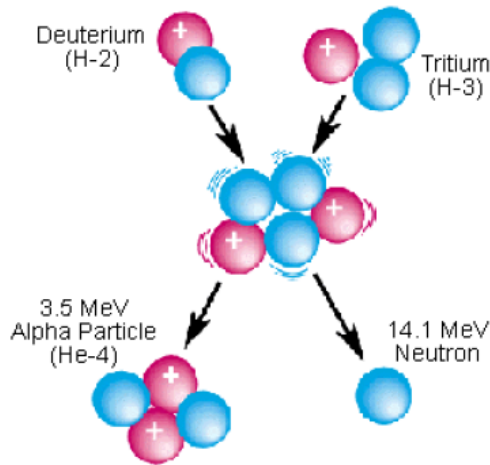

Deuterium-Tritium Fusion Reaction

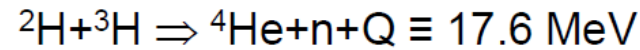

Energy release  $Q=17.6 \text{ MeV}$

In comparison

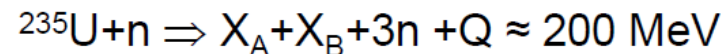
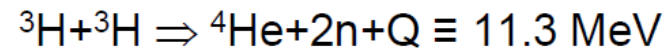
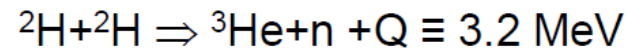
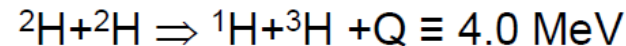

Fusionable Material, deuterium  $^2\text{H}$  (D) and tritium  $^3\text{H}$  (t):

**Deuterium:** natural occurrence (heavy water) (0.015%).

**Tritium:** natural occurrence in atmosphere through cosmic ray bombardment; radioactive with  $T_{1/2}=12.3 \text{ y}$ .

# Enormous fusion fuel can be produced from sea water

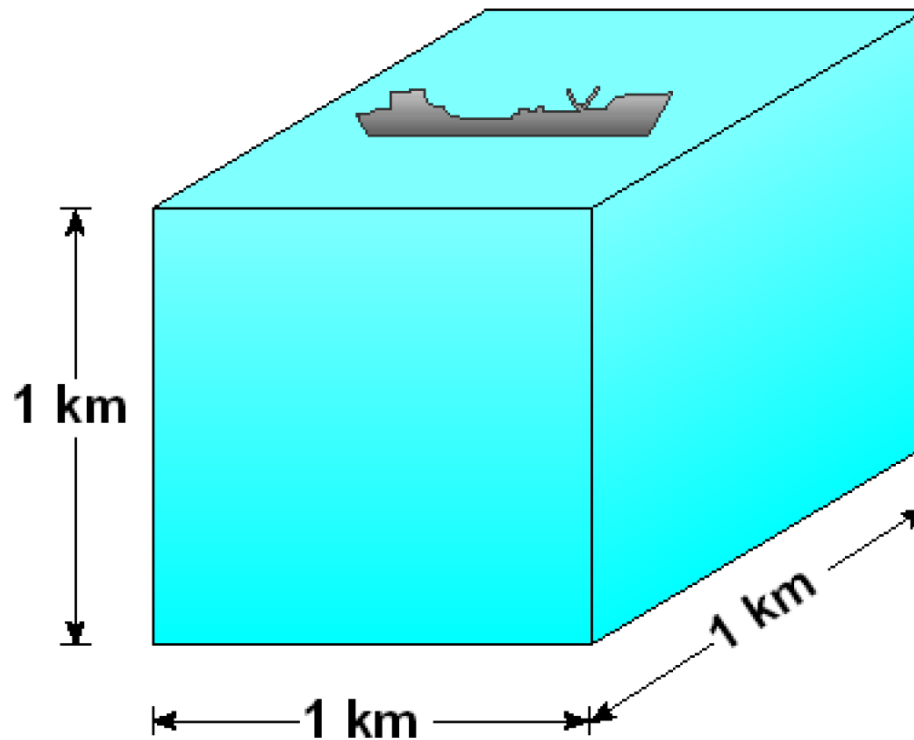

= Total energy  
of world oil  
reserve

# “Advantages” of hydrogen bomb



$$\text{Fusion of } ^2\text{H} + ^3\text{H}: \quad \frac{Q}{A} = \frac{17.6 \text{ MeV}}{(3 + 2) \text{ amu}} = 3.5 \frac{\text{MeV}}{\text{amu}}$$

$$\text{Fission of } ^{235}\text{U}: \quad \frac{Q}{A} = \frac{200 \text{ MeV}}{236 \text{ amu}} = 0.85 \frac{\text{MeV}}{\text{amu}}$$

Fusion is 4 times more powerful than fission  
and generates 24 times more neutrons!



# Fusion doesn't come easily



averaged reaction rate :  $\langle \sigma v \rangle = \int \int d\vec{v}_1 d\vec{v}_2 \sigma_{1,2}(v) v f_1(v_1)$

$$f_j(v_j) = \left( \frac{m_j}{2\pi k_B T} \right)^{3/2} \exp \left( -\frac{m_j v_j^2}{2k_B T} \right)$$

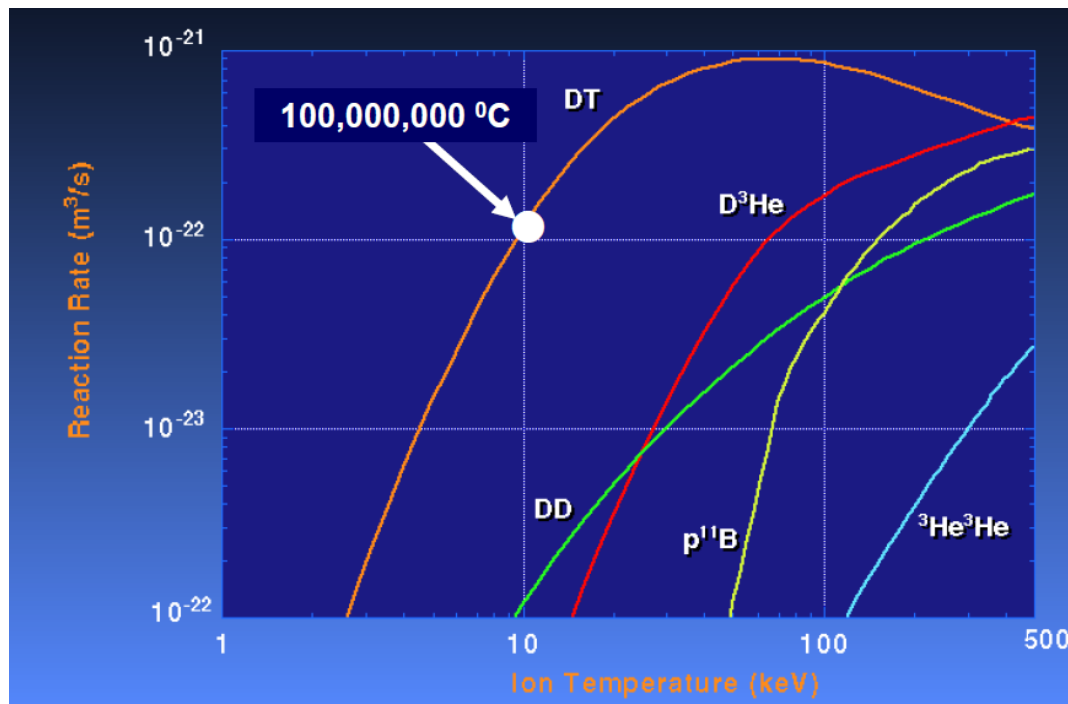

- Use  $\alpha$  particles to heat the plasma  $D + T \rightarrow He^4 (3.5 \text{ MeV}) + n (14.1 \text{ MeV})$

# Magnetic confinement fusion (MCF) vs Inertial confinement fusion (ICF)



## Tokamak

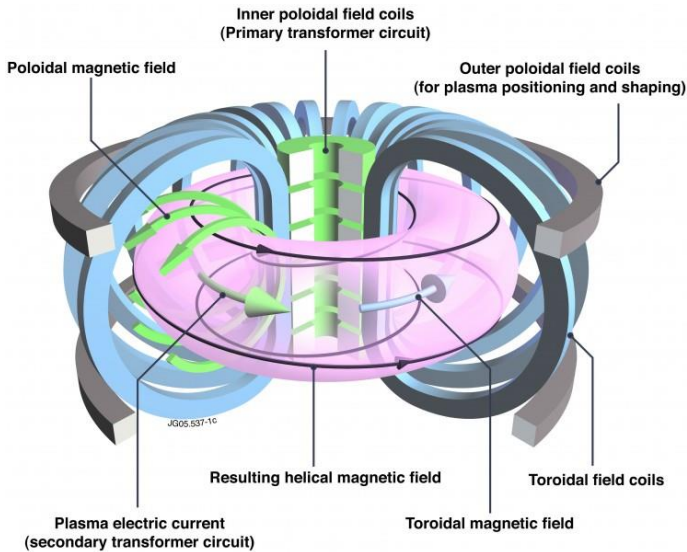

$P \sim \text{atm}, \tau \sim \text{sec}, T \sim 10 \text{ keV}$

## Stellarator

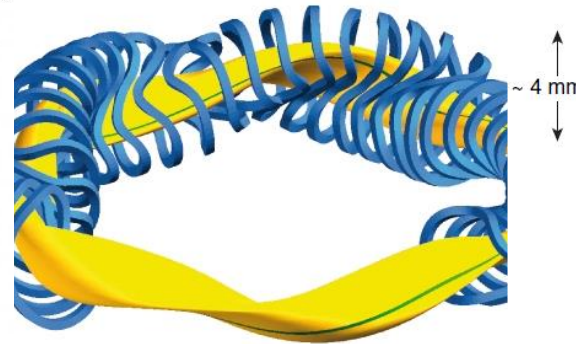

Laser light shines on the target

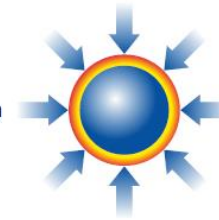

The target is compressed

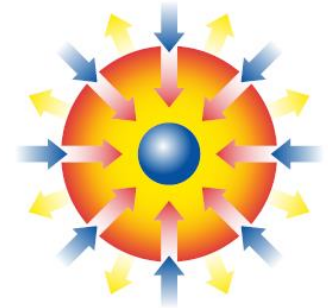

The target is ignited

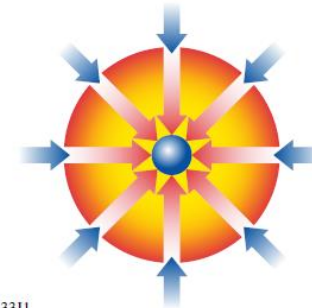

The target burns

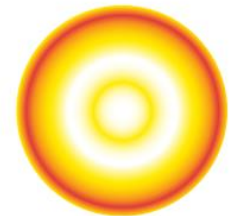

U733J1

$P \sim \text{Gigabar}, \tau \sim \text{nsec}, T \sim 10 \text{ keV}$

# Inertial confinement fusion



Direct-drive target

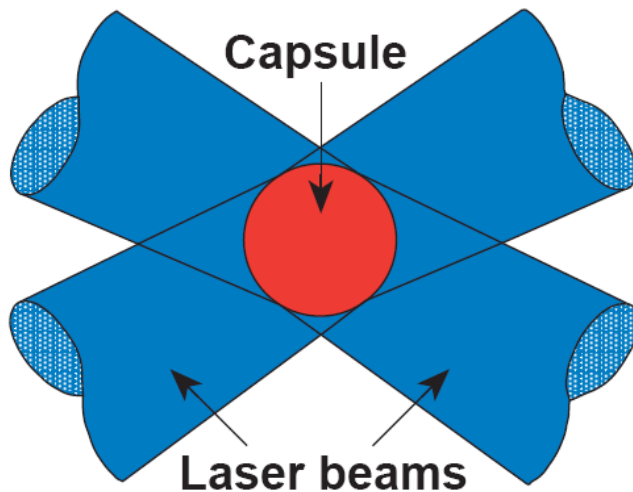

Indirect-drive target

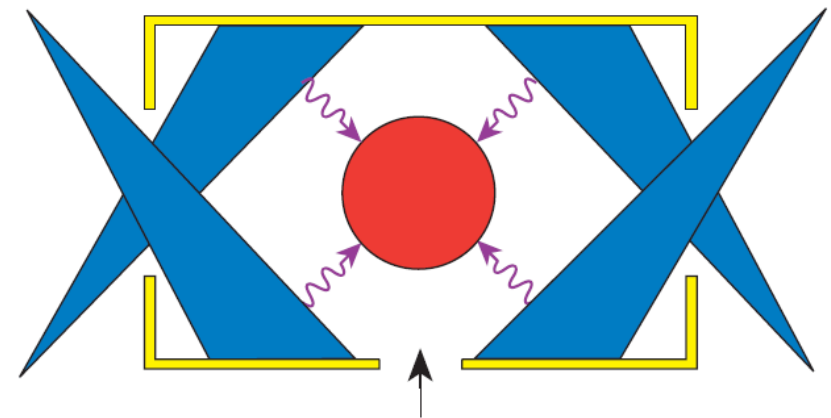

Diagnostic hole

*Hohlraum* using  
a cylindrical high-Z case

Reference:  
Riccardo Betti,  
University of Rochester,  
HEDSA HEDP summer school,  
San Diego, CA, August 16-21, 2015

# Hohlraum at National Ignition Facility (NIF)

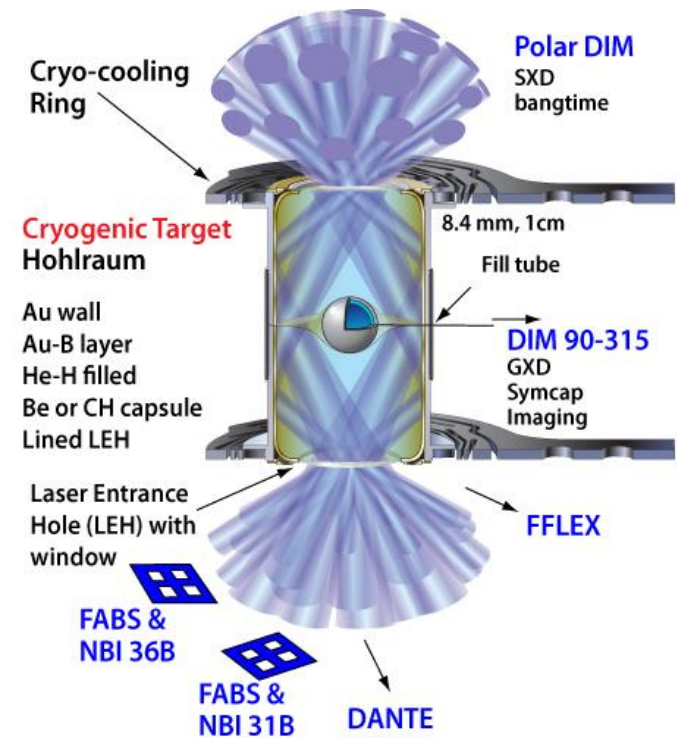
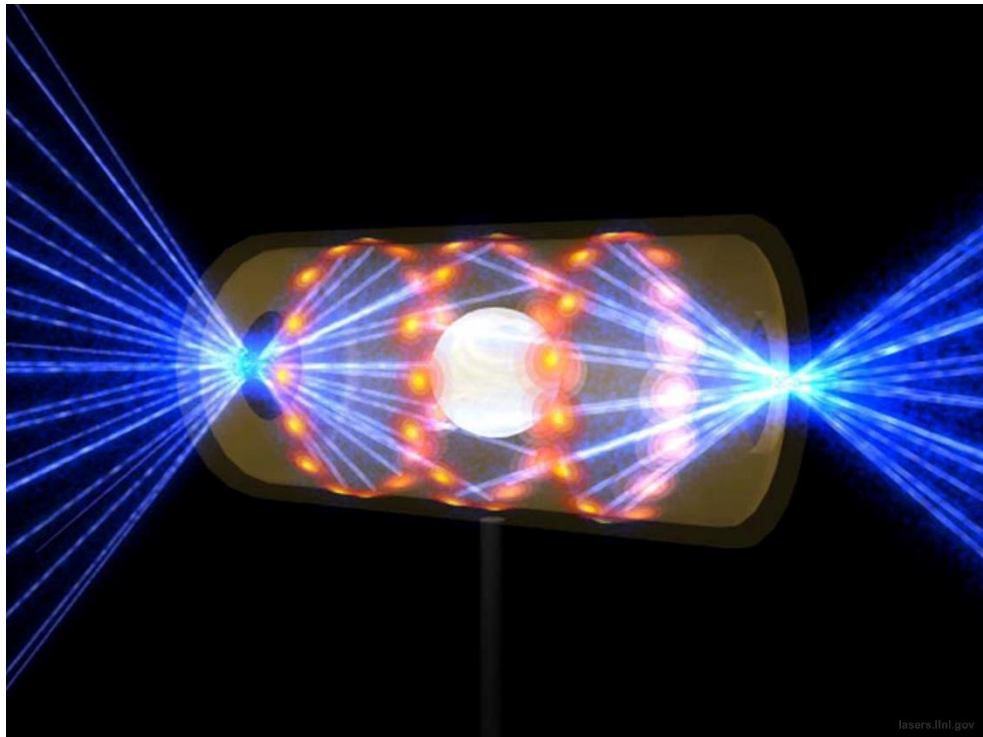

# NIF target

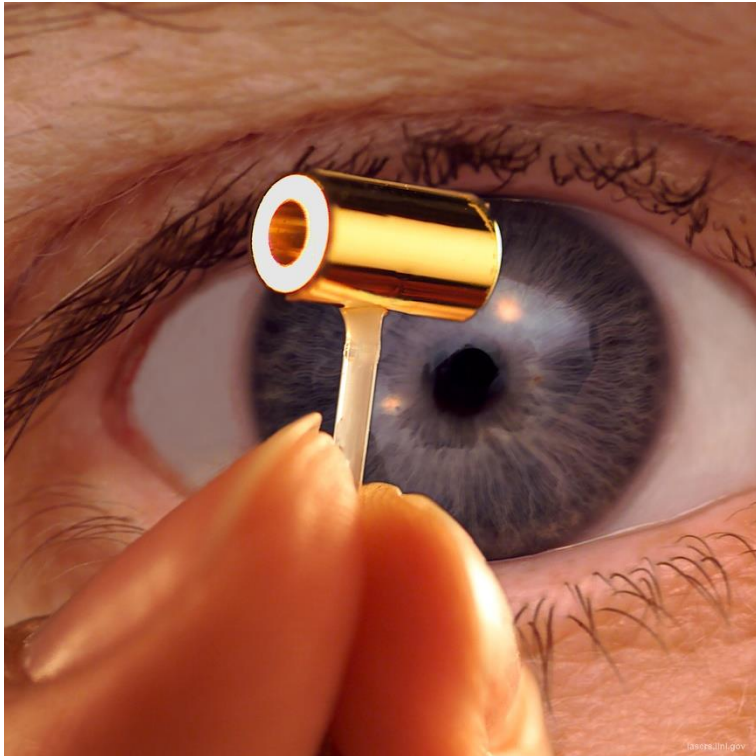



# Targets used in ICF

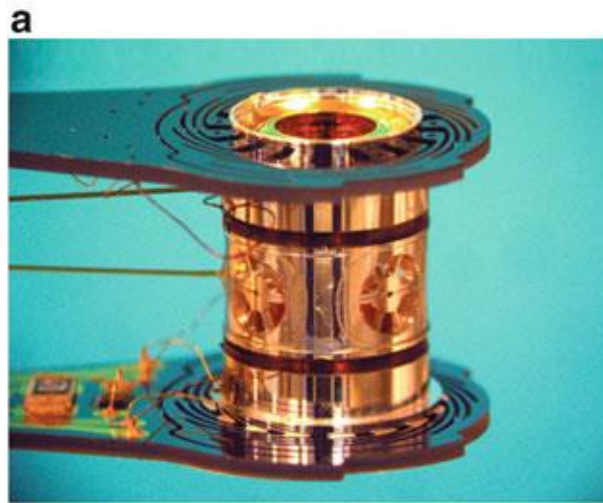
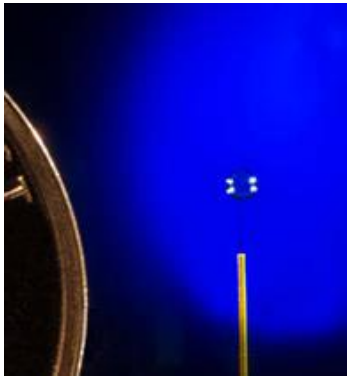

**c Rugby hohlraum**

**d Tent holder**

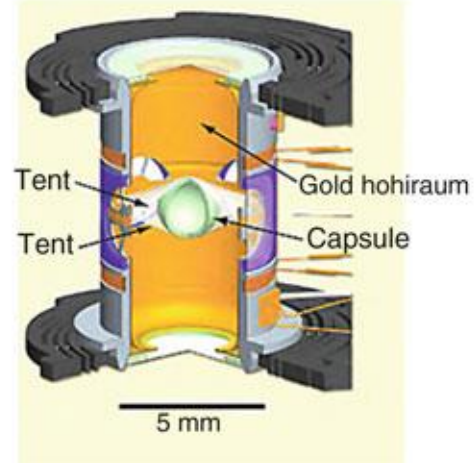
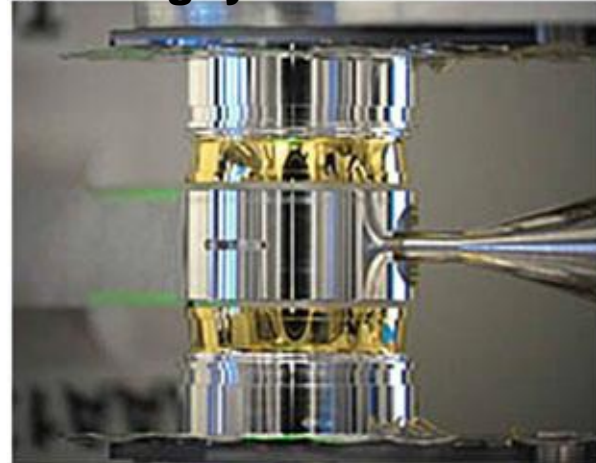
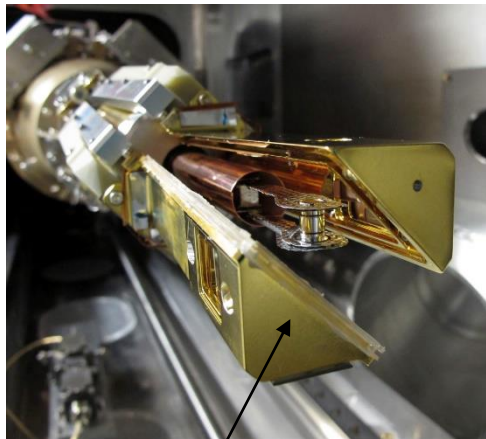

**Cryogenic shroud**

<https://www.lle.rochester.edu>

[https://upload.wikimedia.org/wikipedia/commons/7/7b/Nif-shot\\_target-arm-before\\_big.jpg](https://upload.wikimedia.org/wikipedia/commons/7/7b/Nif-shot_target-arm-before_big.jpg)

<https://www.lle.rochester.edu/index.php/2014/11/10/next-generation-cryo-target/>



# NIF achieved ignition ( $Q=1.5$ ) on Dec. 5, 2022



- Input Laser energy: 2.05 MJ
- Output energy: 3.15 MJ

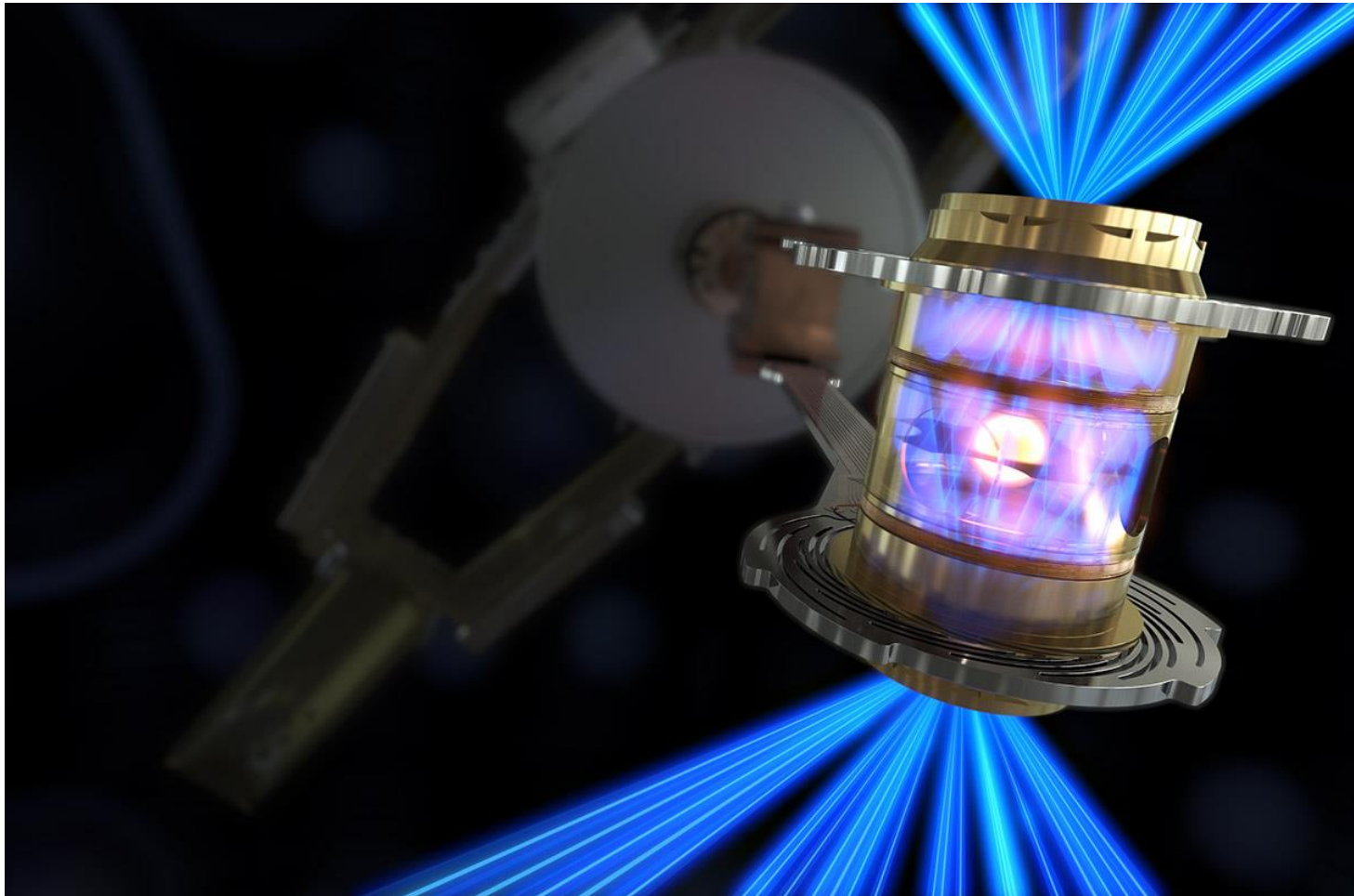

# National Ignition Facility (NIF) achieved a yield of more than 1.3 MJ from ~1.9 MJ of laser energy in 2021 (Q~0.7)

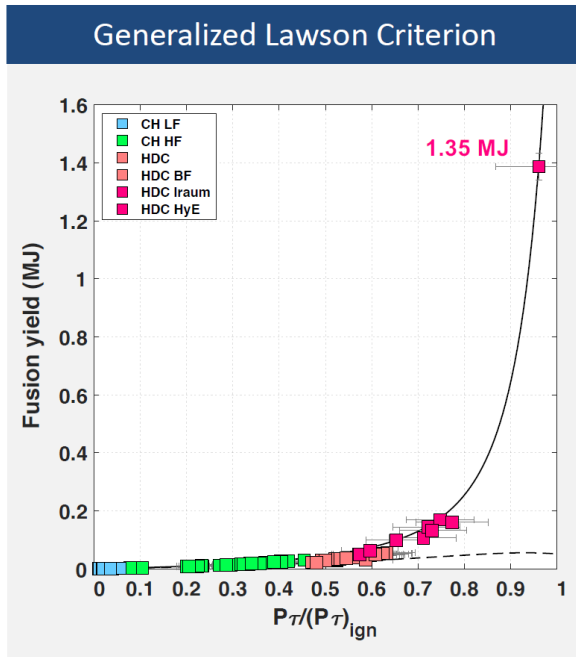

- National Ignition Facility (NIF) achieved a yield of more than 1.3 MJ (Q~0.7). This advancement puts researchers at the threshold of fusion ignition.

## THE ROAD TO IGNITION

The National Ignition Facility (NIF) struggled for years before achieving a high-yield fusion reaction (considered ignition, by some measures) in 2021. Repeat experiments, however, produced less than half the energy of that result.

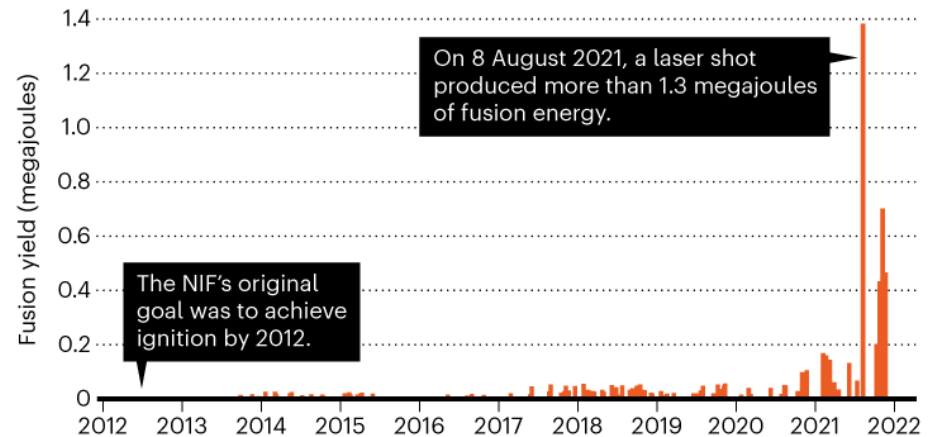

©nature

- Laser-fusion facility heads back to the drawing board.

# “Ignition” (target yield larger than one) was achieved in NIF on 2022/12/5

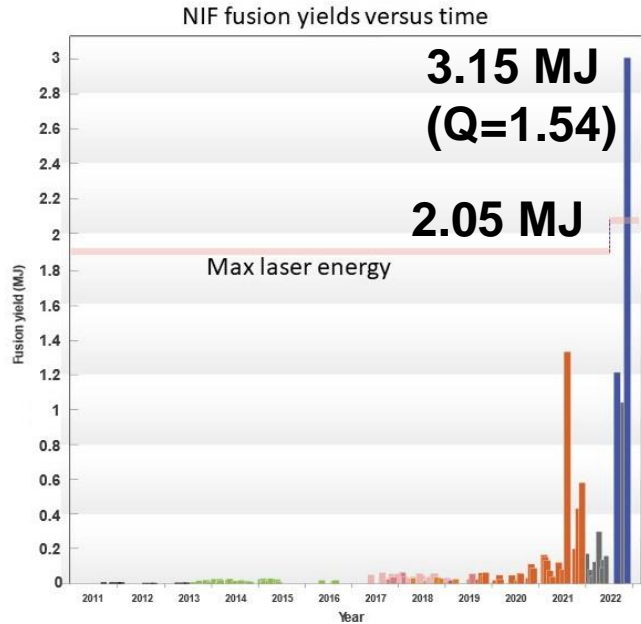

## NIF's ignition achievement in perspective

Energy in megajoules ● = 1

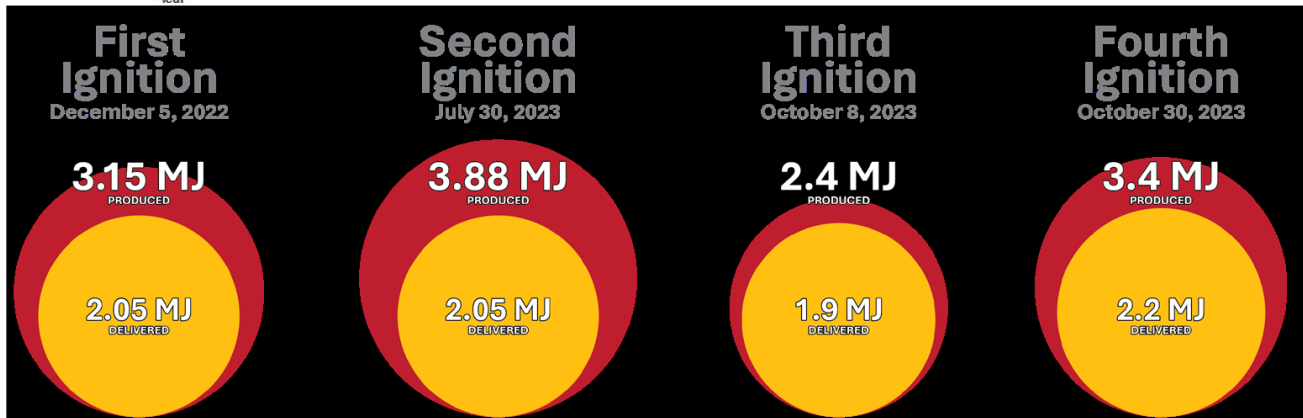
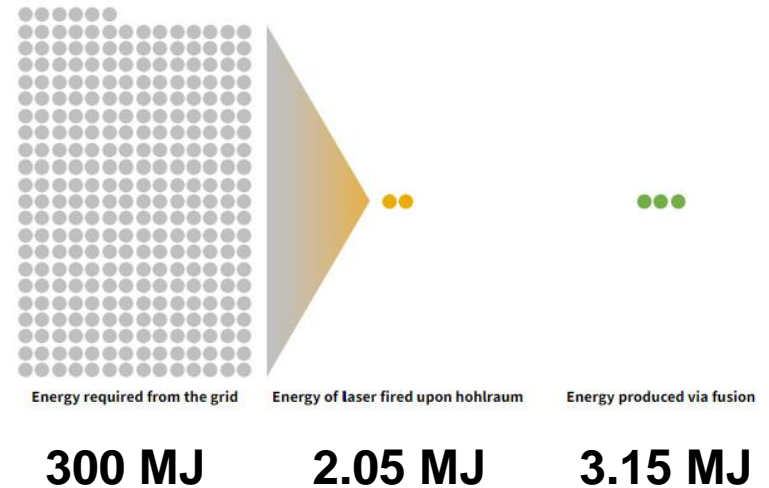

<https://physicstoday.scitation.org/doi/10.1063/PT.6.2.20221213a/full/>  
 The age of ignition: anniversary edition, LLNL-BR-857901

# ICF via z pinch or z-pinch driven dynamic-hohlraums

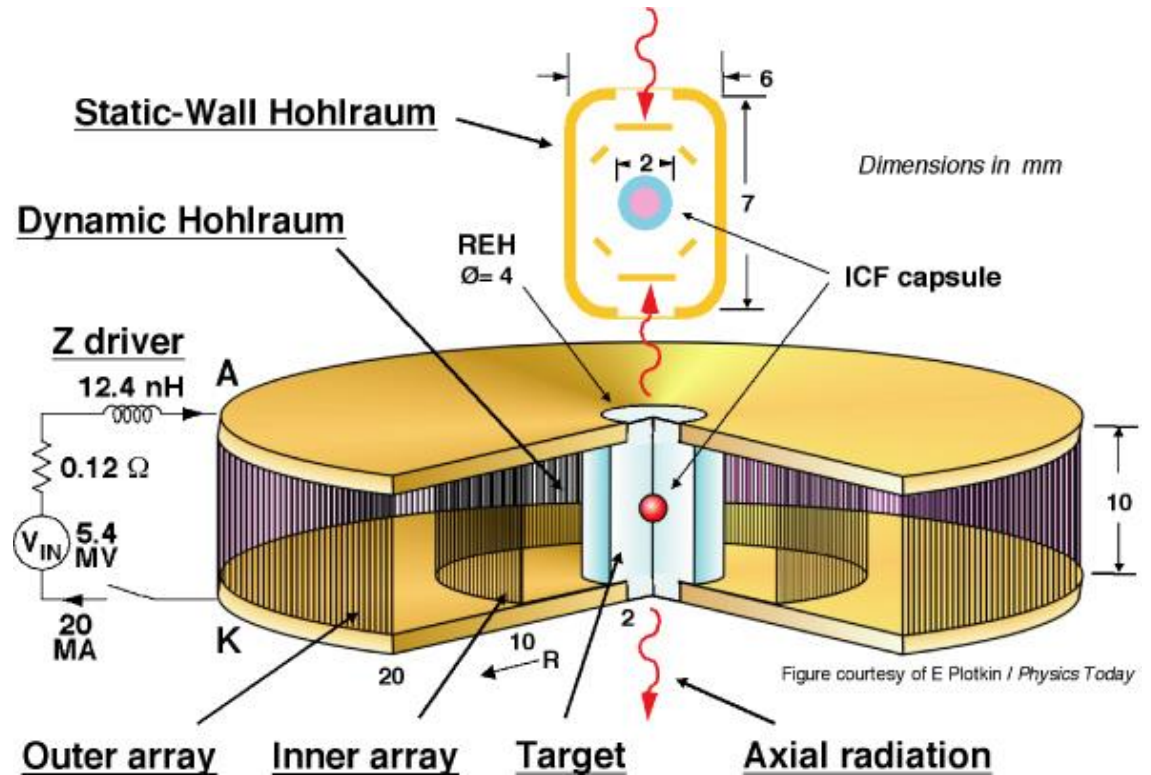
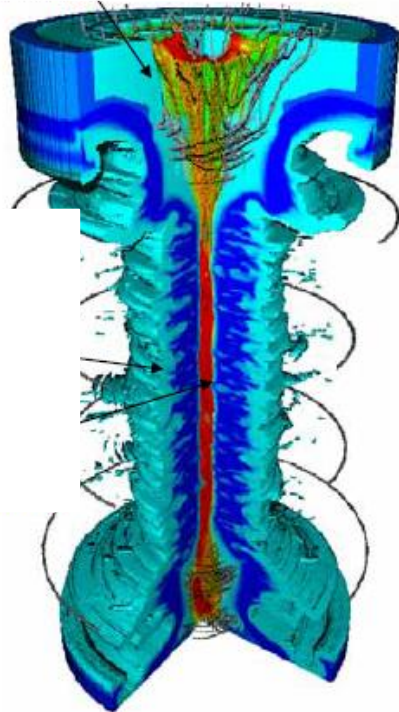

# magnetized liner inertial fusion (MagLIF)

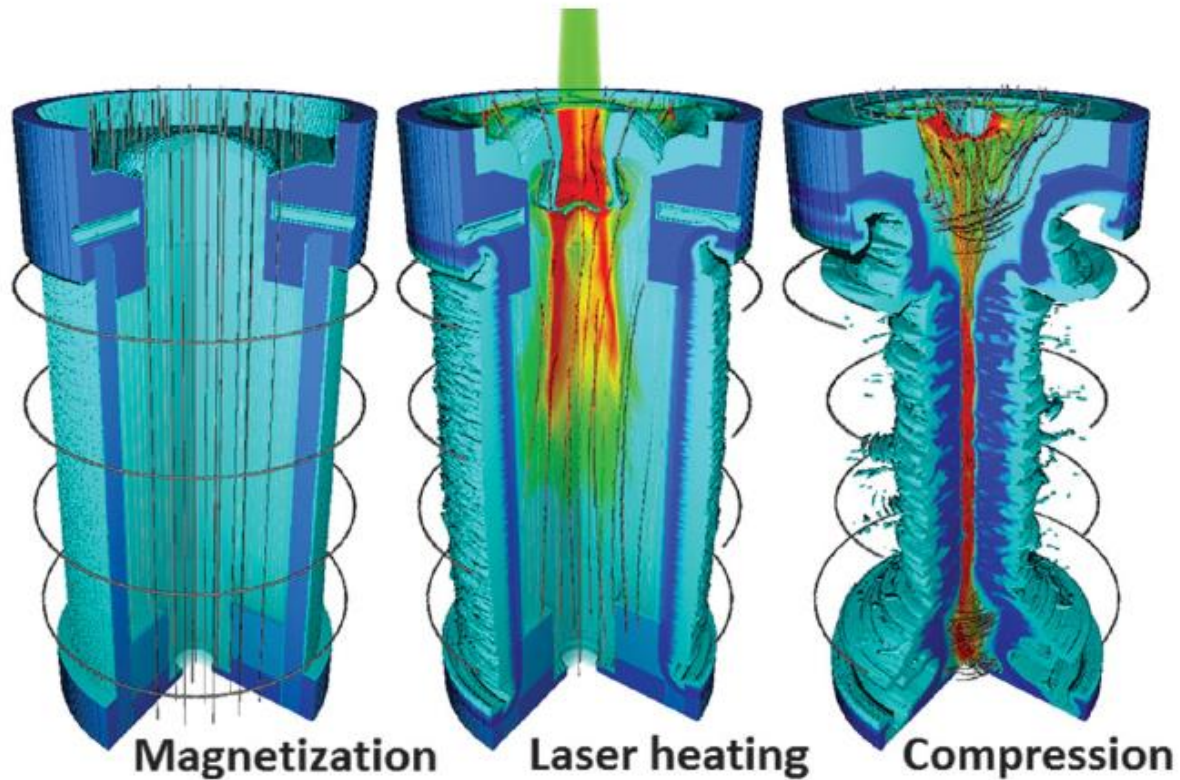



# MagLIF target

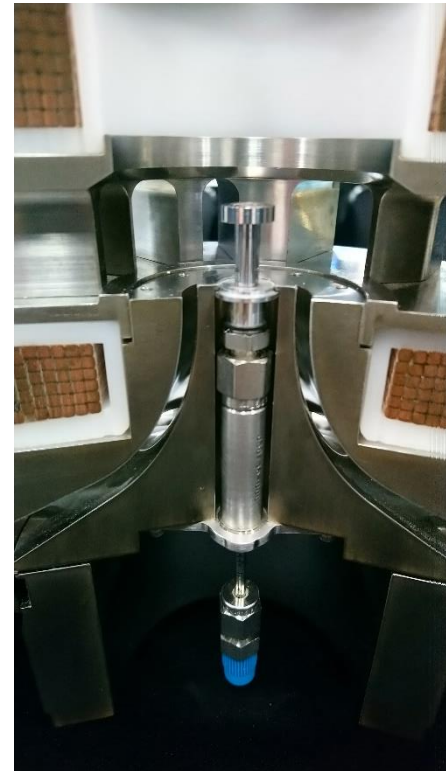
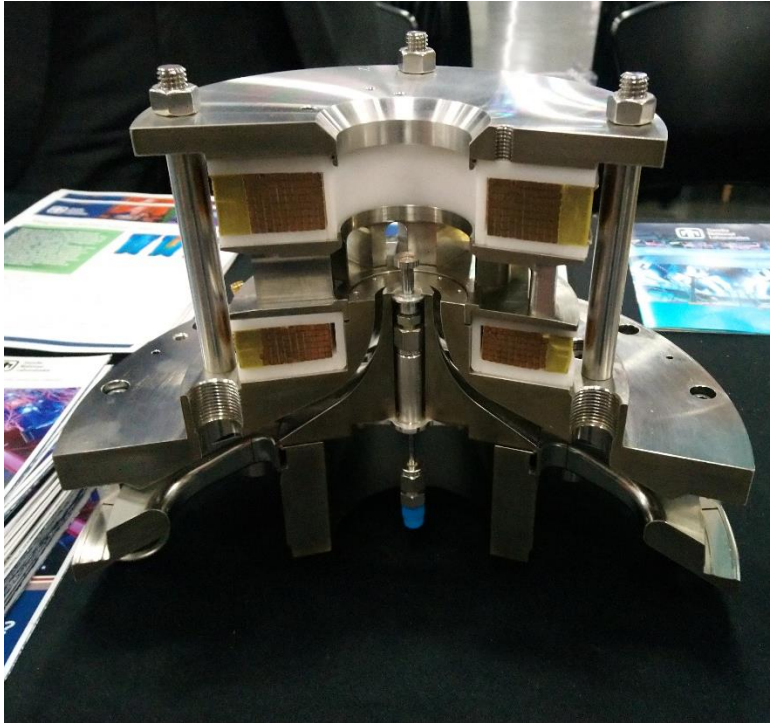



# Neutron yield increased by 100x with preheat and external magnetic field.

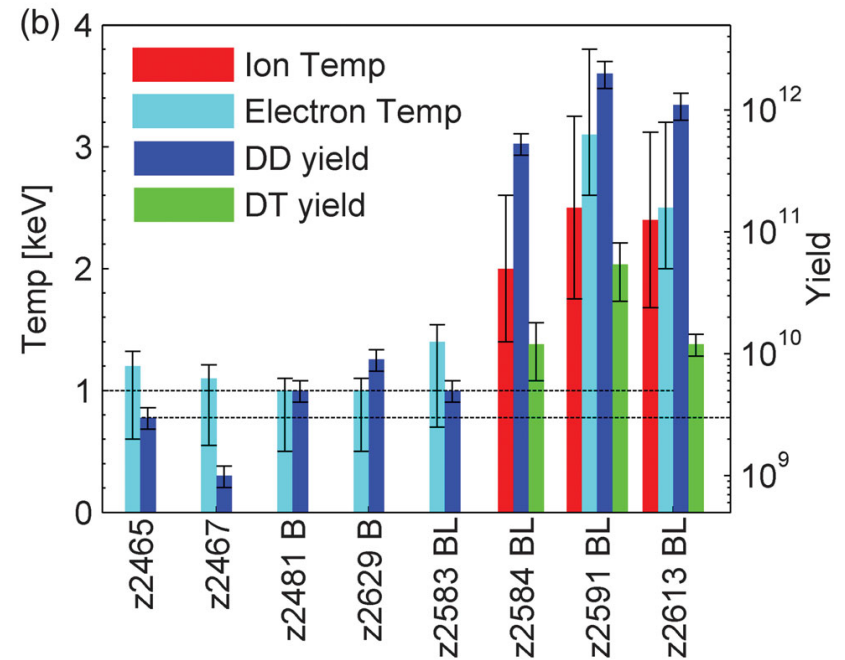
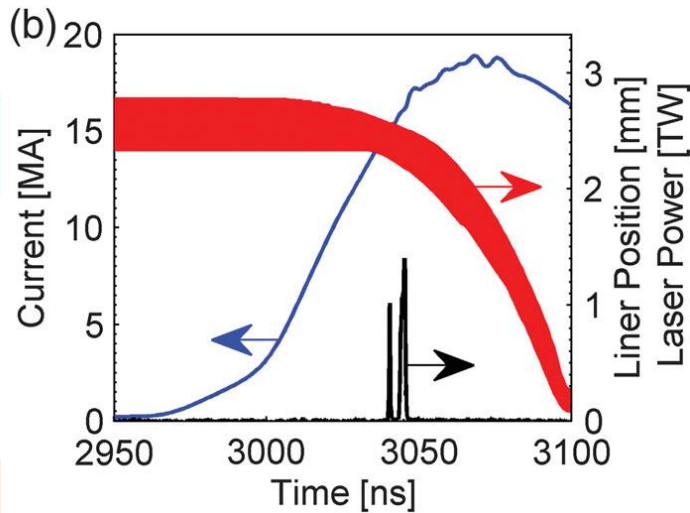
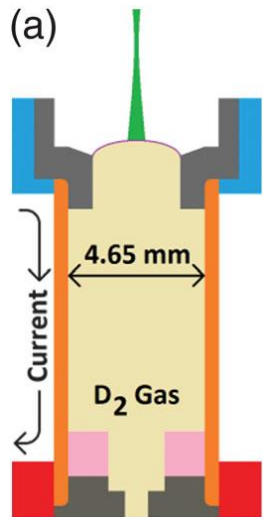

# Sheared flow stabilizes MHD instabilities



$m = 0$  (sausage)

Perturbation  $\propto e^{(im\theta + ikz + \gamma t)}$

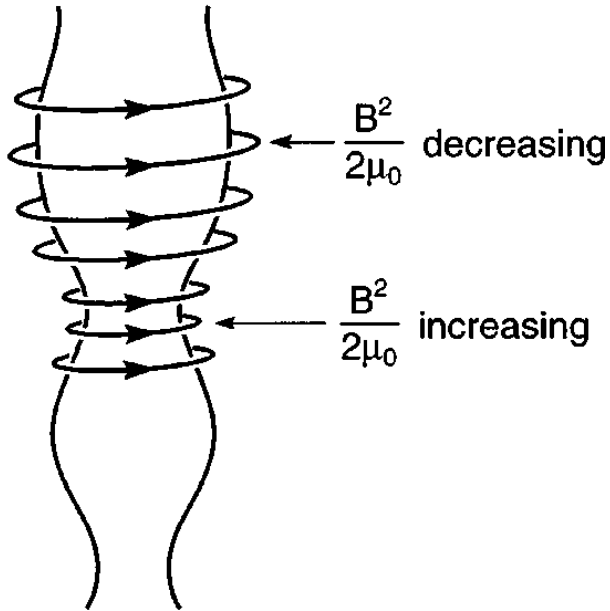

$m = 1$  (kink)

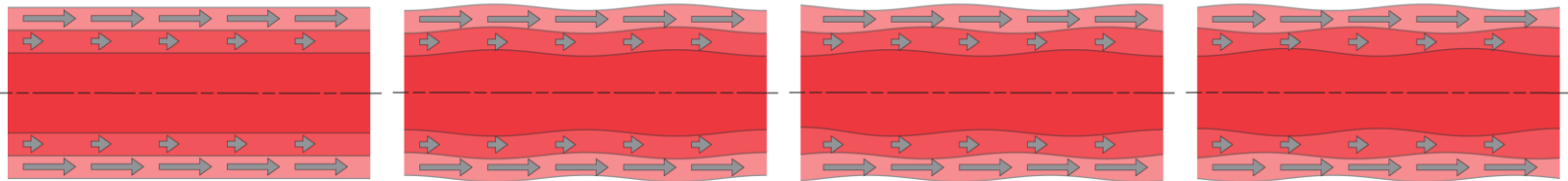
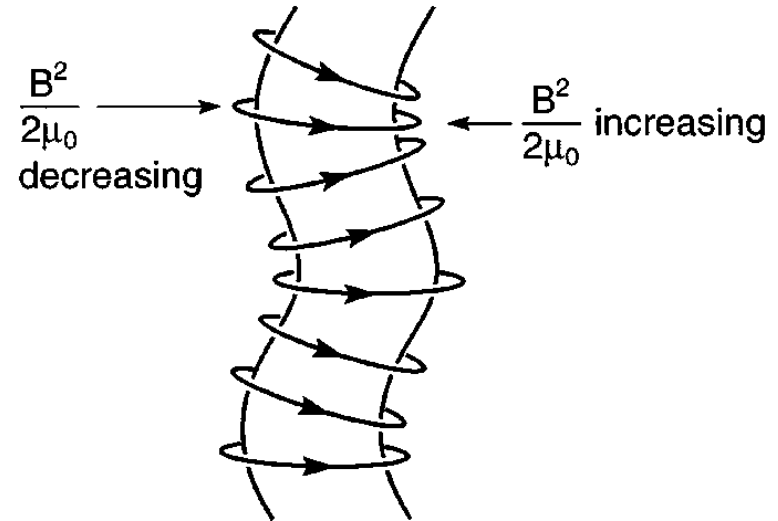

$$\frac{dV_z}{dr} \neq 0$$

M. G. Haines, etc., Phys. Plasmas 7, 1672 (2000)  
 U. Shumlak, etc., Physical Rev. Lett. 75, 3285 (1995)  
 U. Shumlak, etc., ALPHA Annual Review Meeting 2017

# A z-pinch plasma can be stabilized by sheared flows

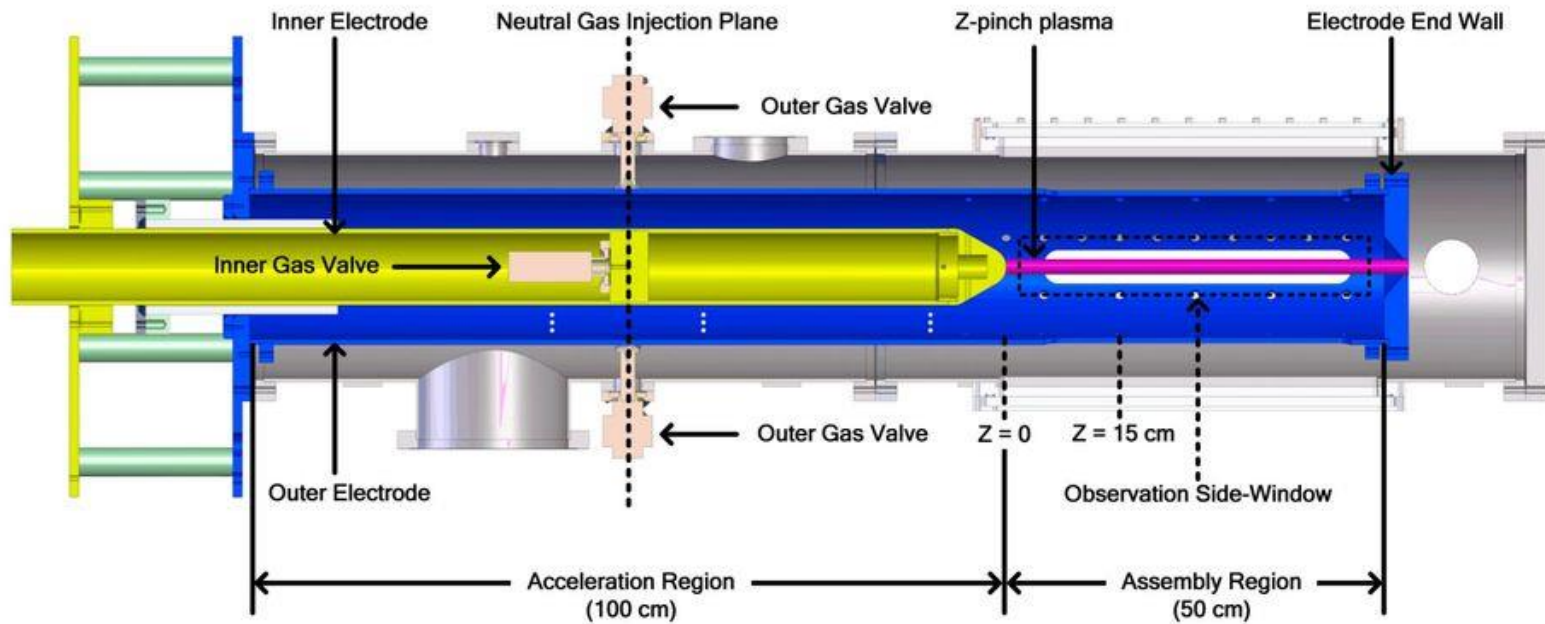
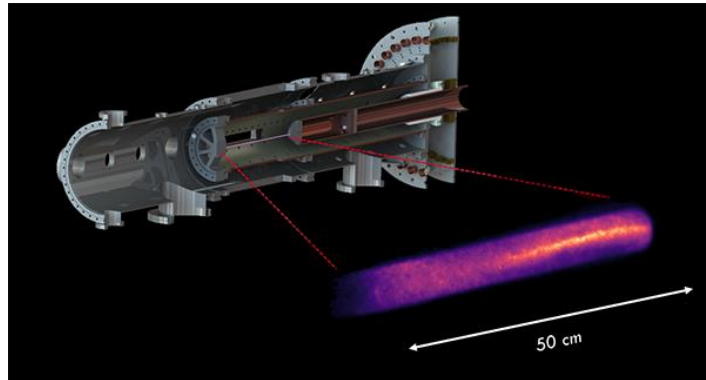

# Fusion reactor concept by ZAP energy

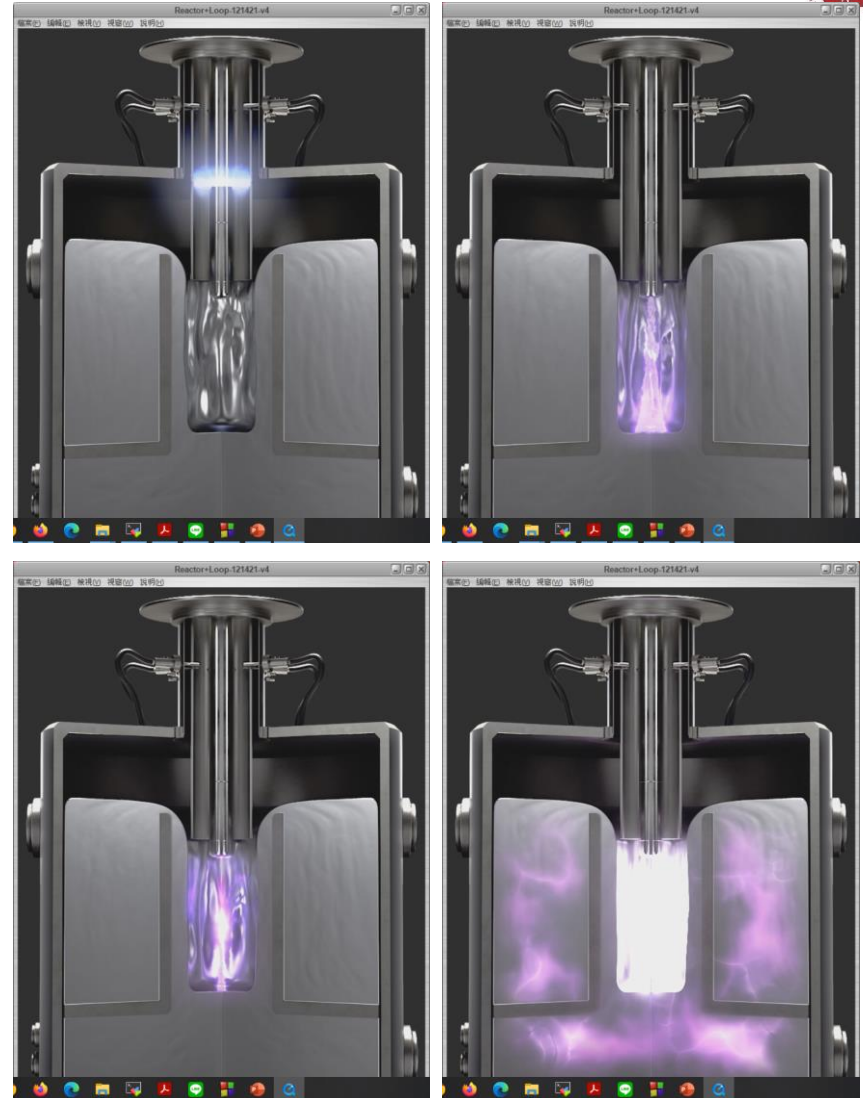
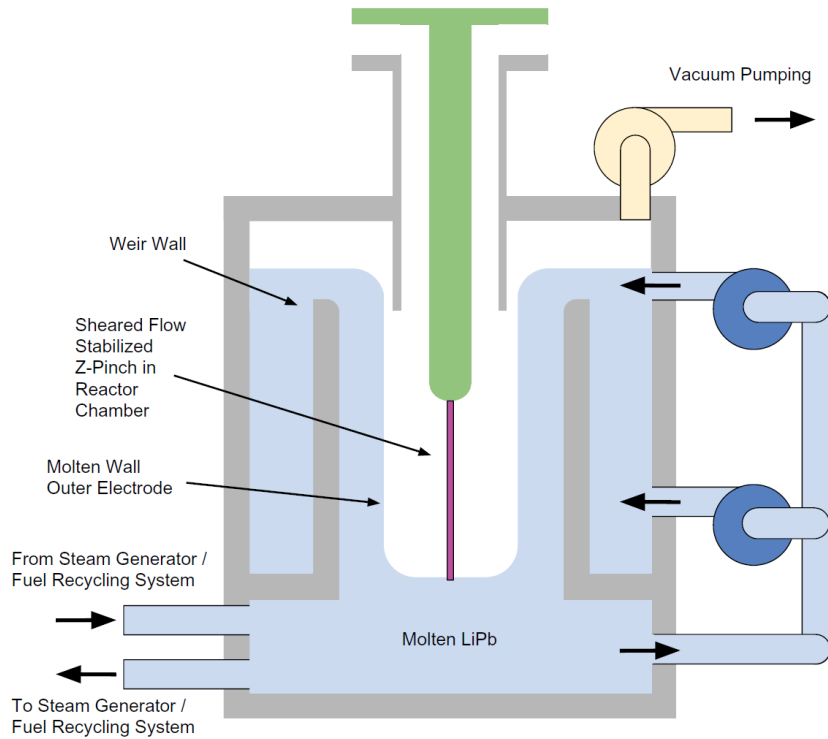

# First light fusion, UK

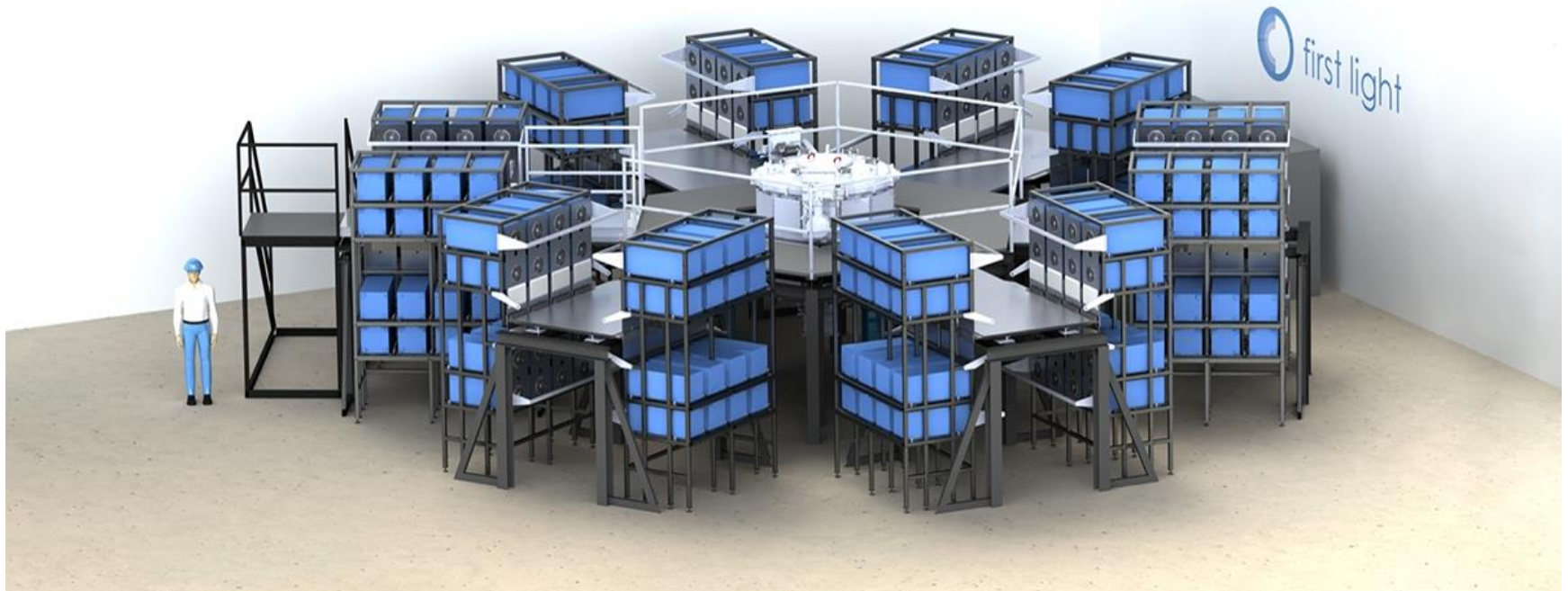

- **2.5 MJ @ 200 kV**
- **14 MA with  $t_{\text{rise}} \sim 2 \text{ us}$**



# First light fusion, UK

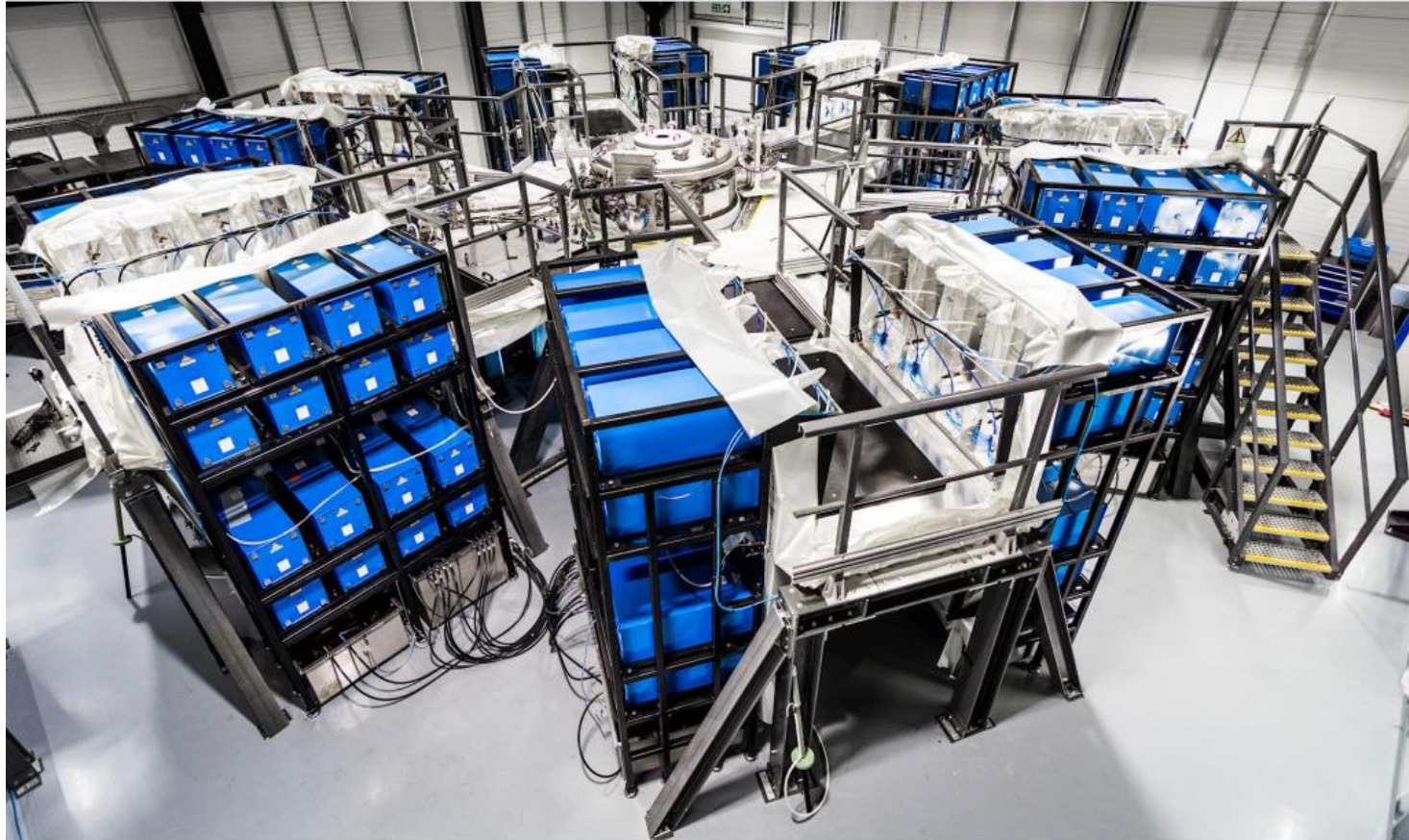

[https://www.all-electronics.de/wp-content/uploads/2019/08/1\\_Pic\\_192-capacitors-around-vacuum-chamber\\_lowres-1024x768.jpg](https://www.all-electronics.de/wp-content/uploads/2019/08/1_Pic_192-capacitors-around-vacuum-chamber_lowres-1024x768.jpg)



# Projectile Fusion is being established at First Light Fusion Ltd, UK



- **Stored energy: 2.5 MJ @ 200 kV**  
( $C_{\text{tot}}=125 \mu\text{F}$ )
- $I_{\text{peak}}=14 \text{ MA w/ } T_{\text{rise}} \sim 2 \mu\text{s.}$

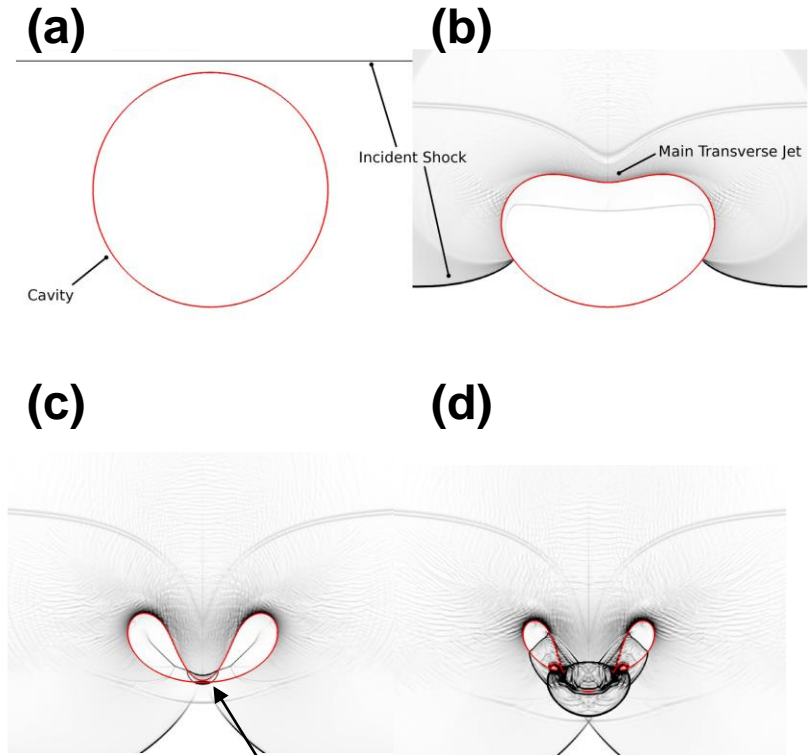
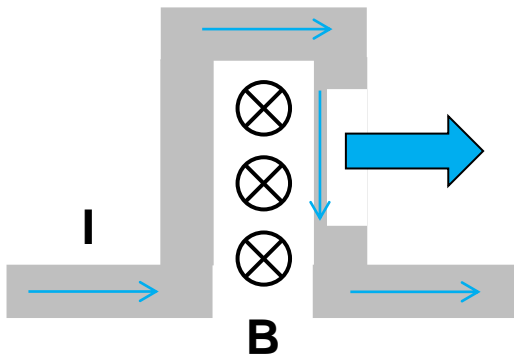

- **High pressure is generated by the colliding shock.**

<https://firstlightfusion.com/>

B. Tully and N. Hawker, Phys. Rev. **E93**, 053105 (2016)

# First light fusion, UK – achieving ignition using shock wave

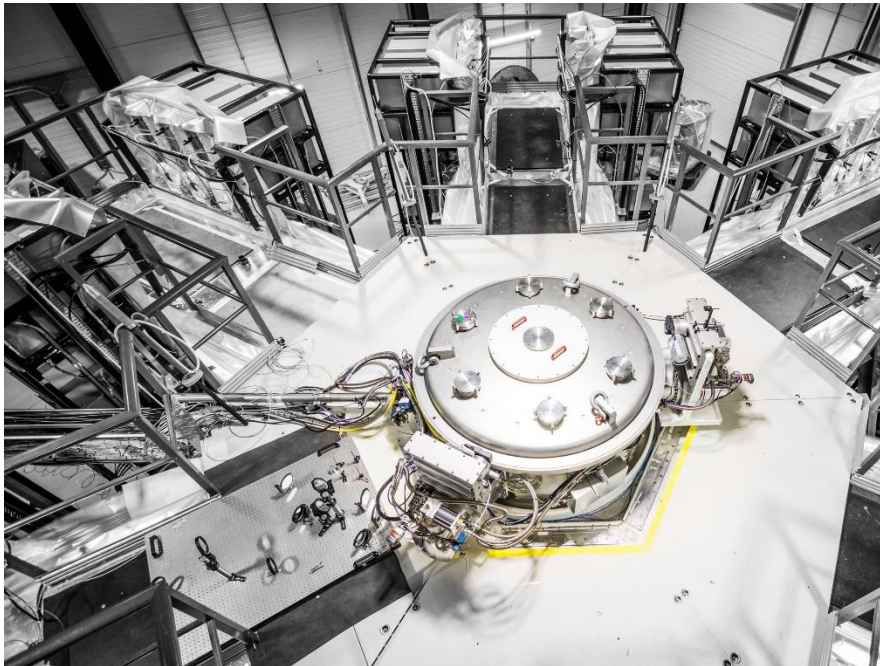

## First Light Fusion

First Light Fusion is a spin-off from Oxford University department of mechanical engineering and claims to be able to harness instabilities by using asymmetrical implosion.

See <http://firstlightfusion.com/>

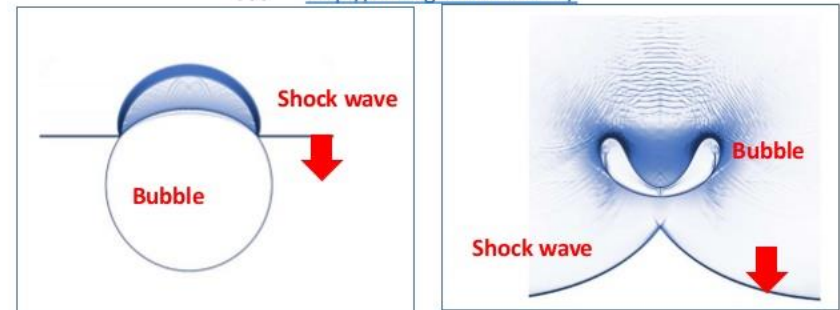

# A gas gun is used to eject the projectile



<https://www.youtube.com/watch?v=JN7lyxC11n0>

<https://www.youtube.com/watch?v=aW4eufac-f8>



# The pulsed-power system was built by only students

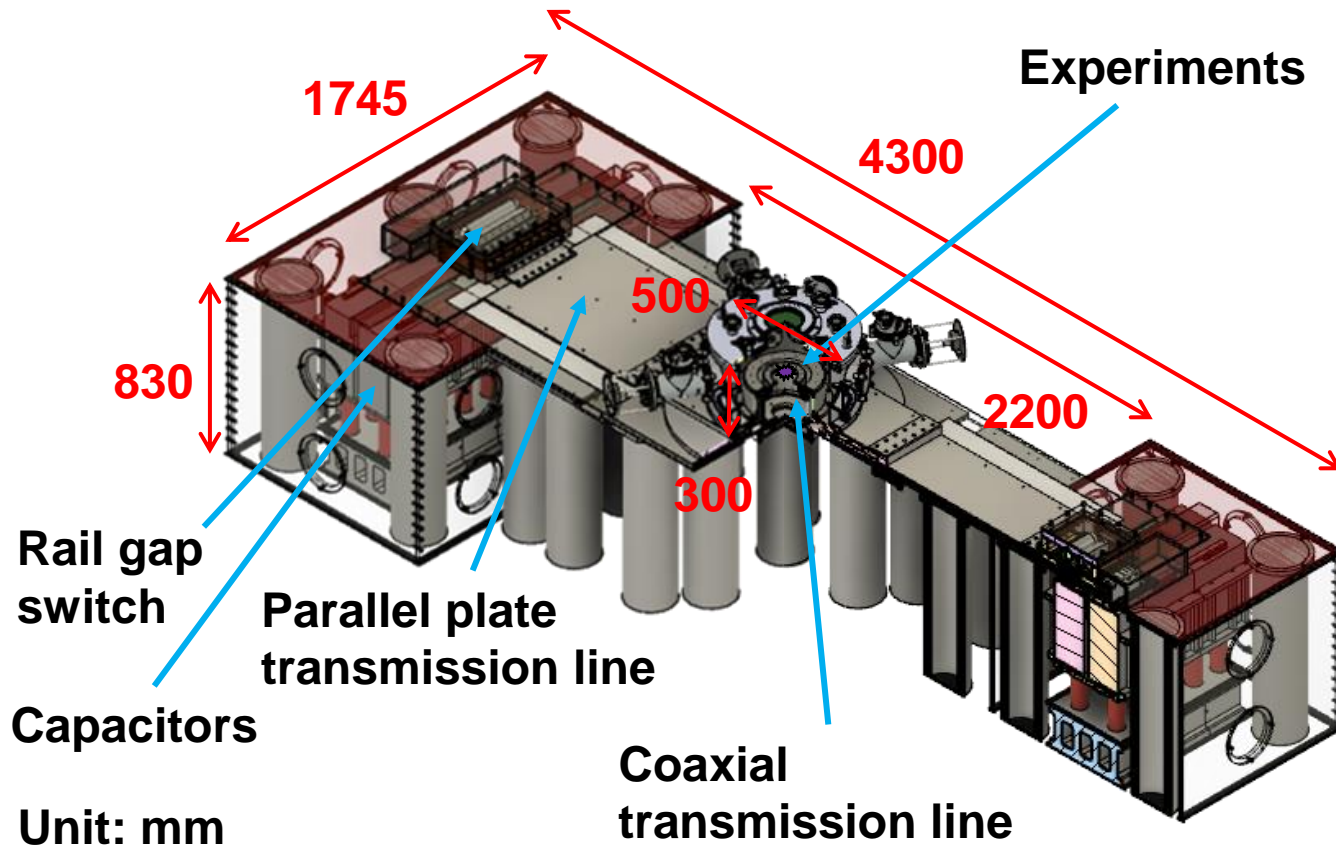

- A 1 kJ pulsed-power system at ISAPS, NCKU started being operated since September, 2019.

# The 1-kJ pulsed-power system

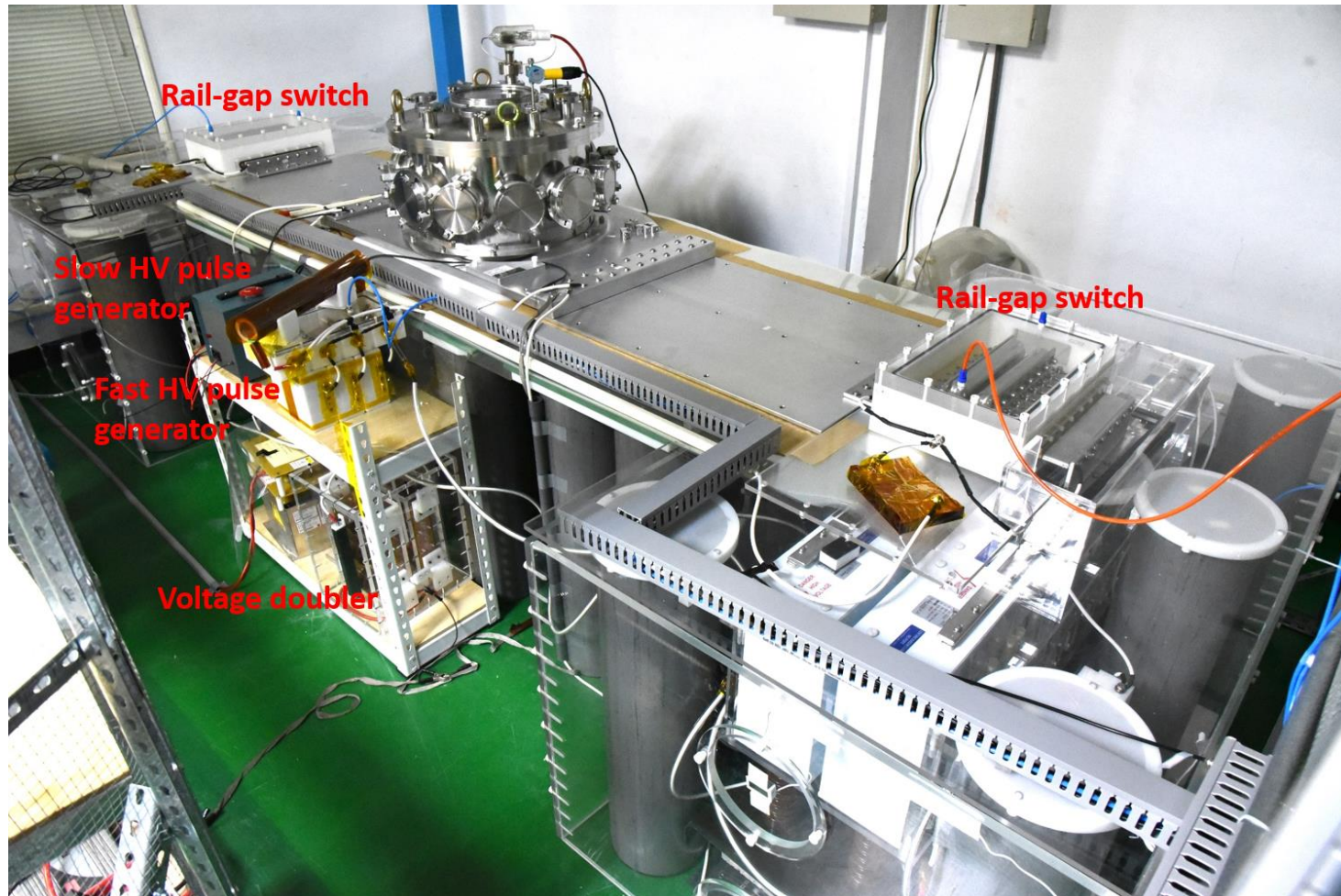

# A peak current of $\sim 135$ kA with a rise time of $\sim 1.6$ $\mu$ s is provided by the pulsed-power system

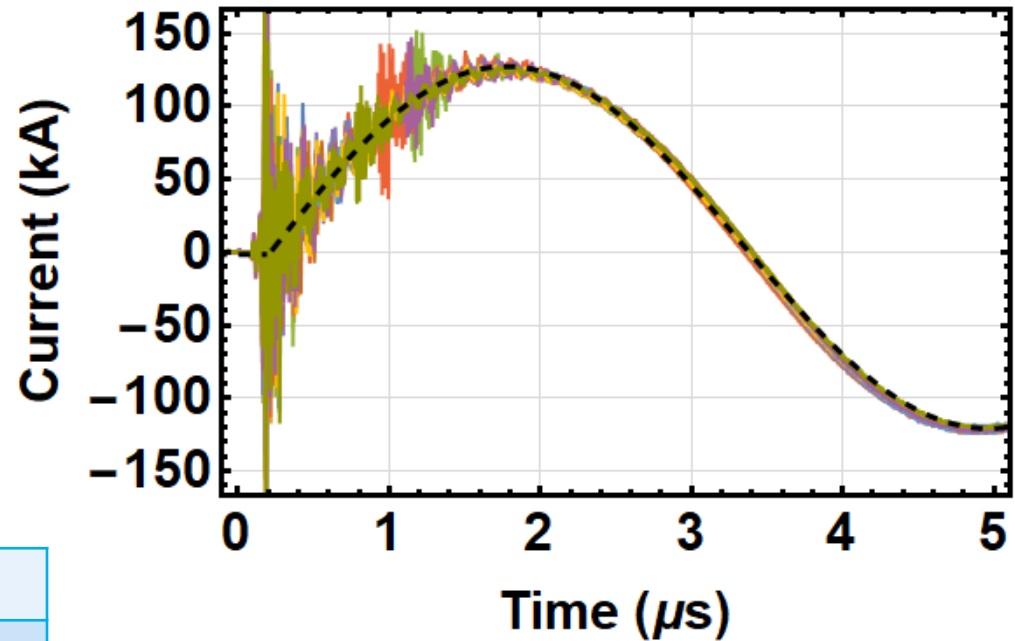
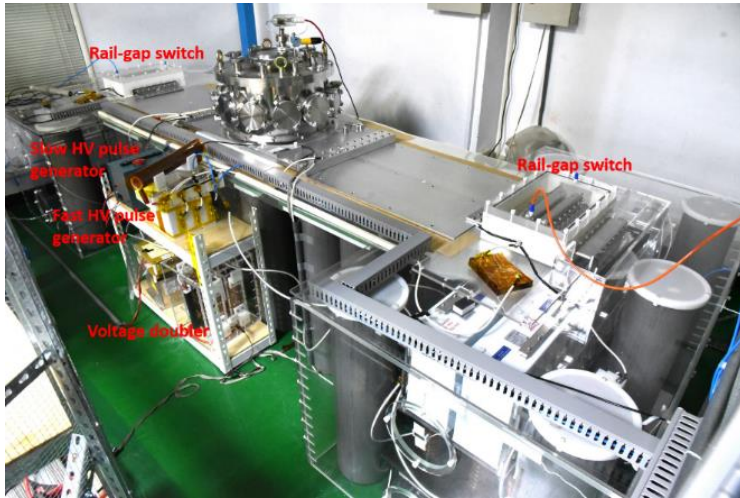

Capacitance ( $\mu$ F)	5
$V_{\text{charge}}$ (kV)	20
Energy (kJ)	1
Inductance (nH)	$204 \pm 4$
Rise time (quarter period, ns)	$1592 \pm 3$
$I_{\text{peak}}$ (kA)	$135 \pm 1$



# First shot with two synchronized rail-gap switches

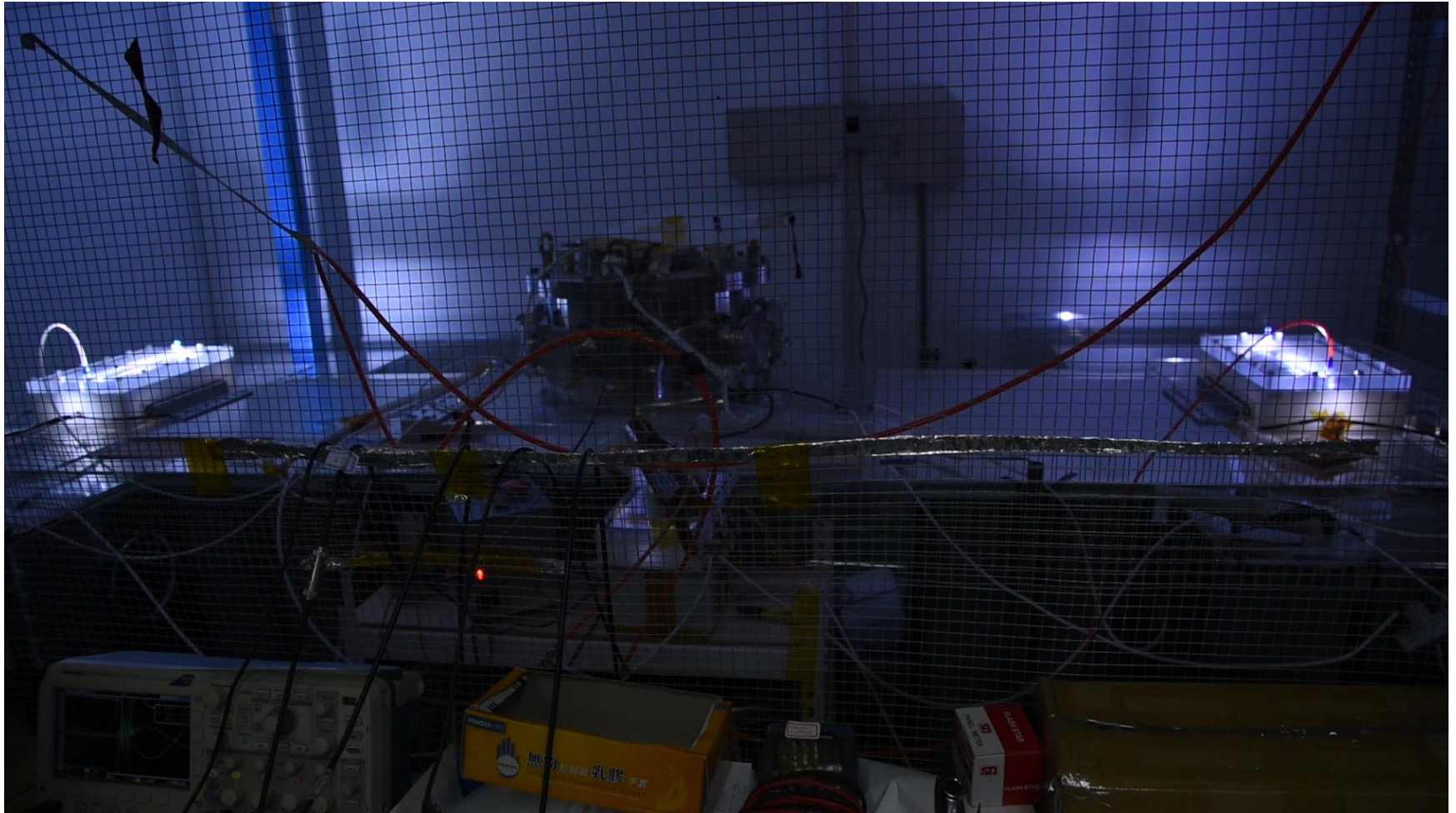

# Time-resolved imaging system with temporal resolution in the order of nanoseconds was implemented

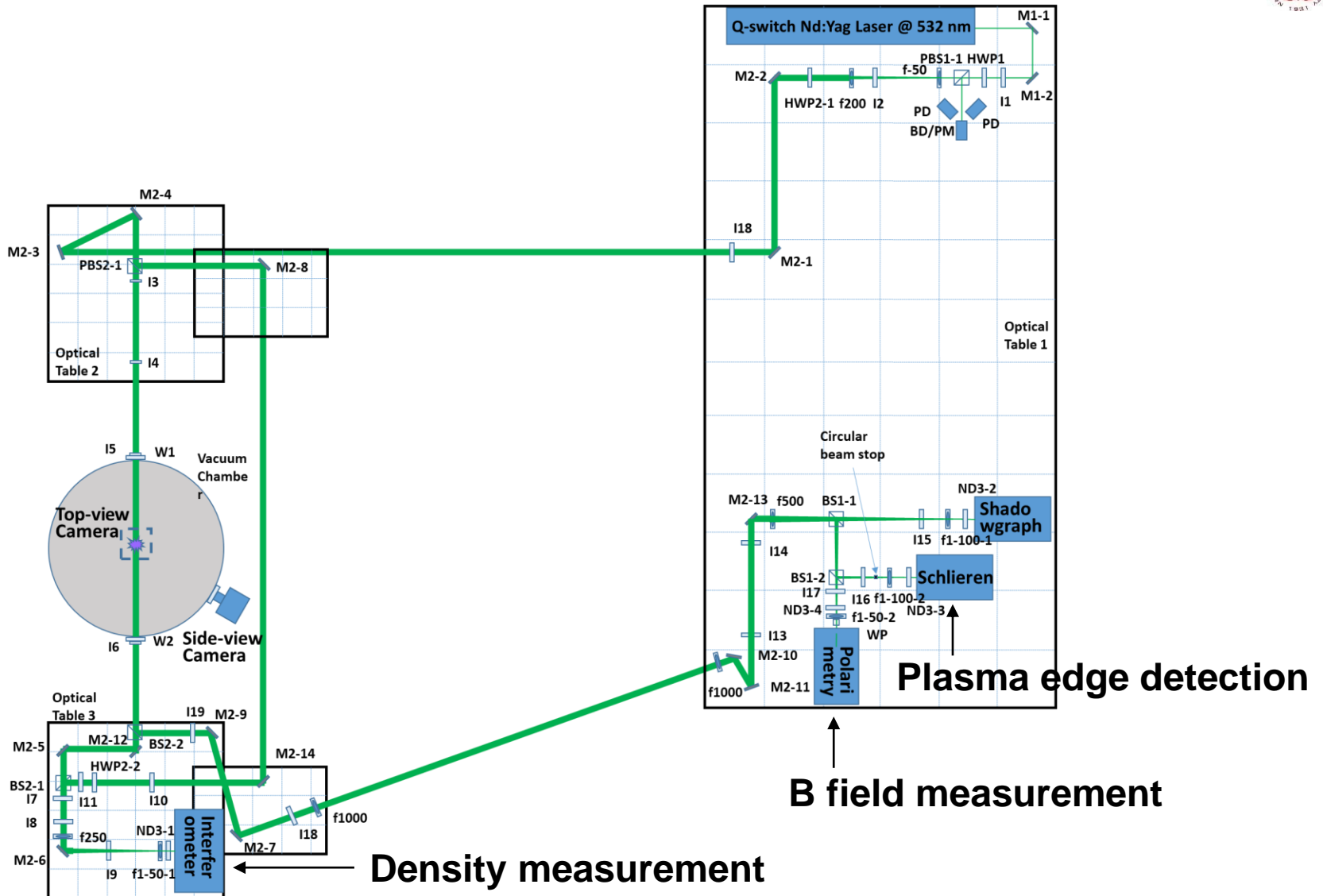

# Varies diagnostics were integrated to the system

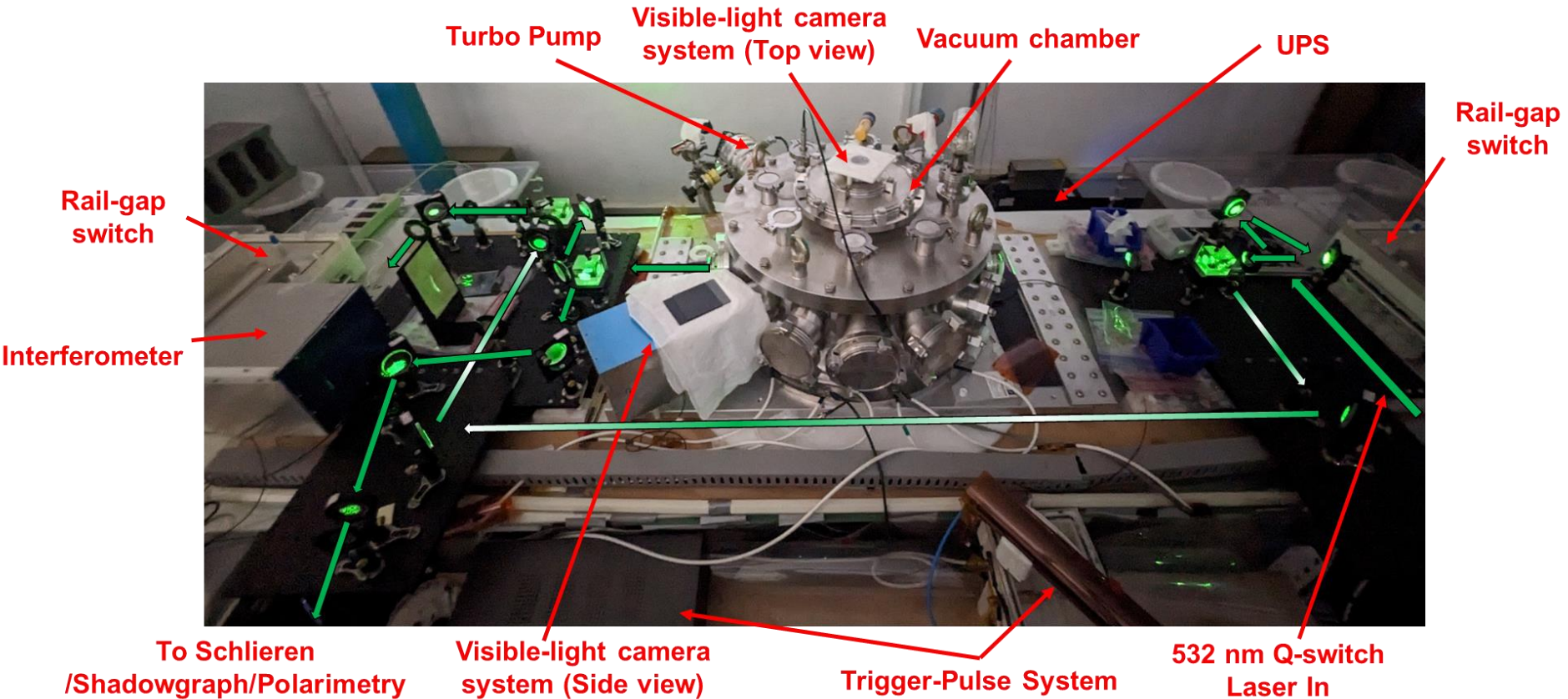



# Beam path

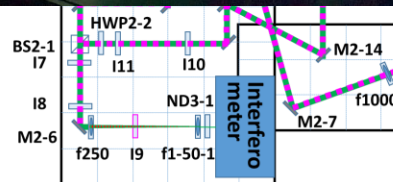
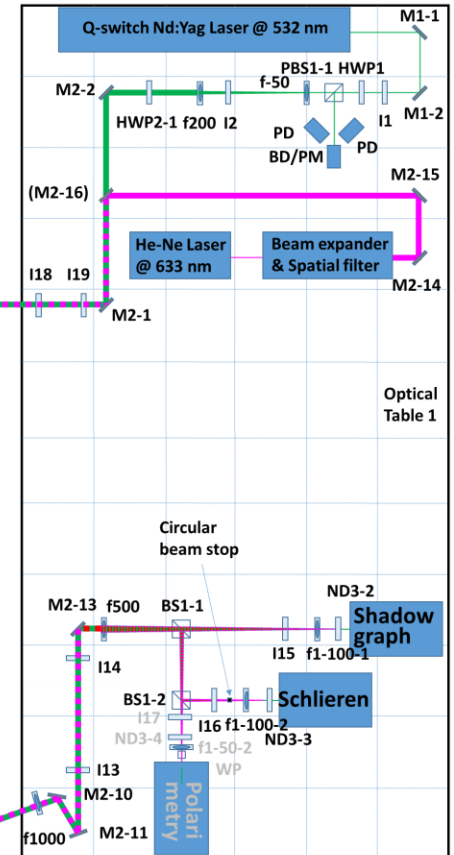

# Beam path

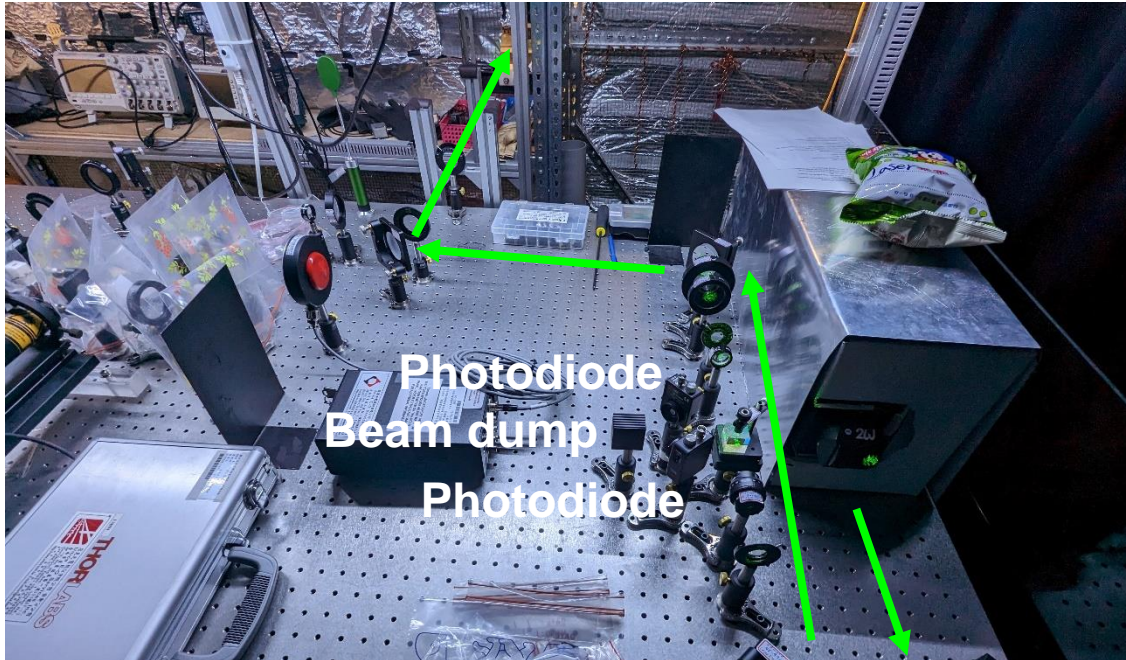

Photodiode  
Beam dump  
Photodiode

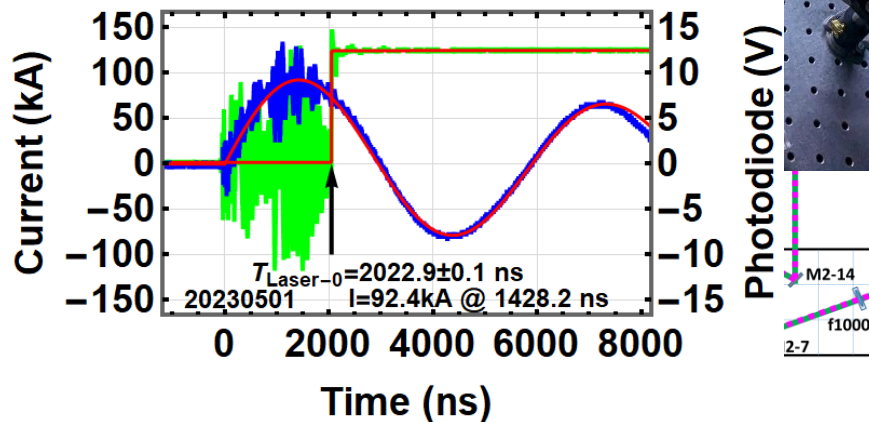
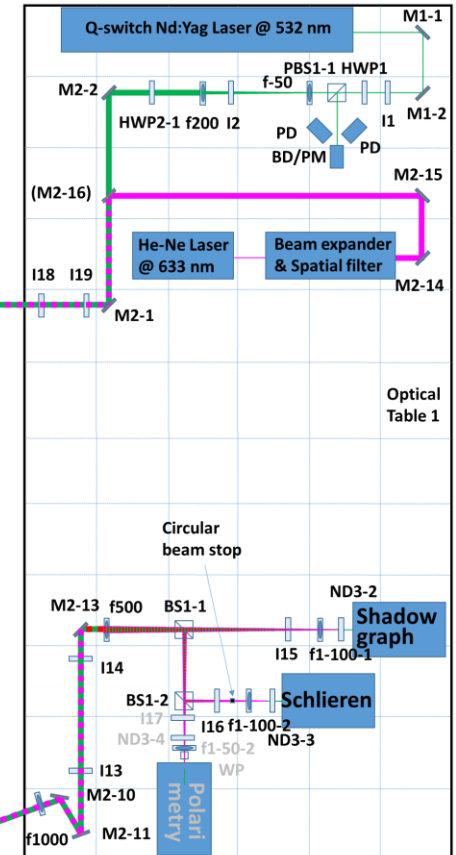



# Beam path

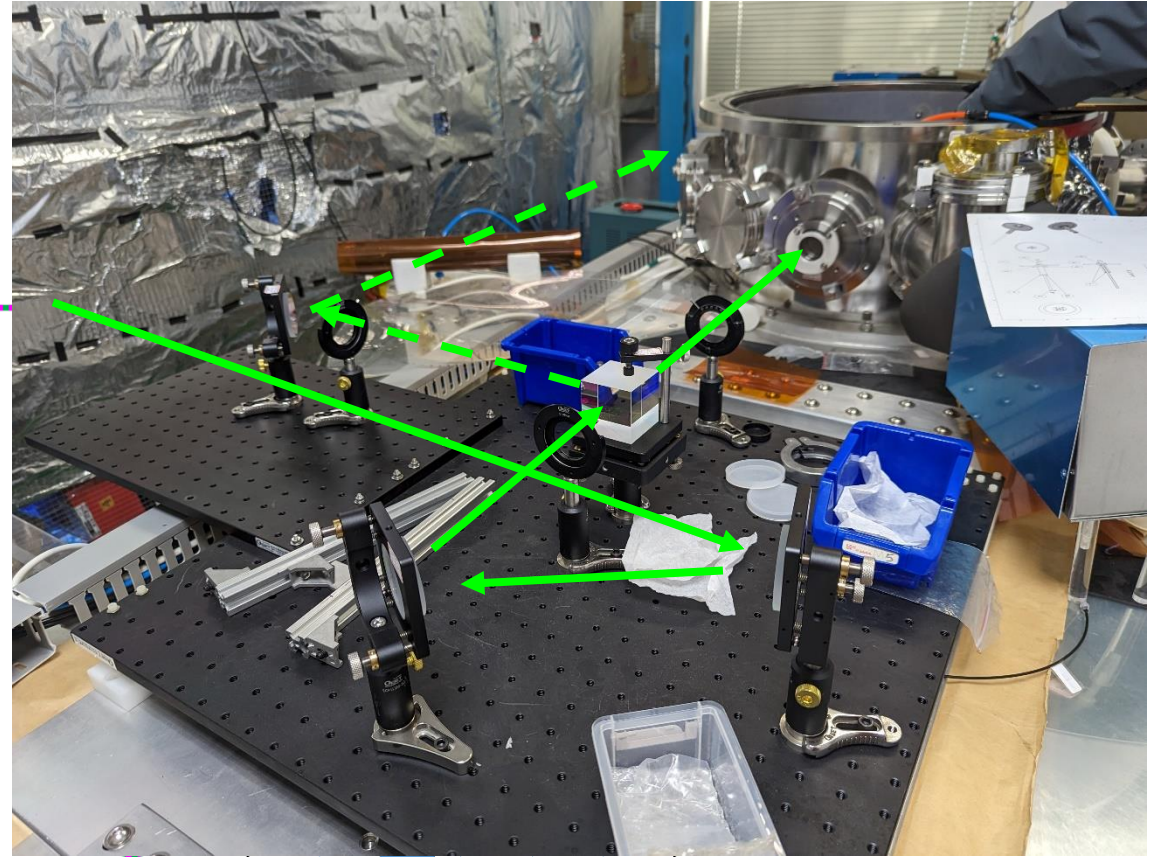
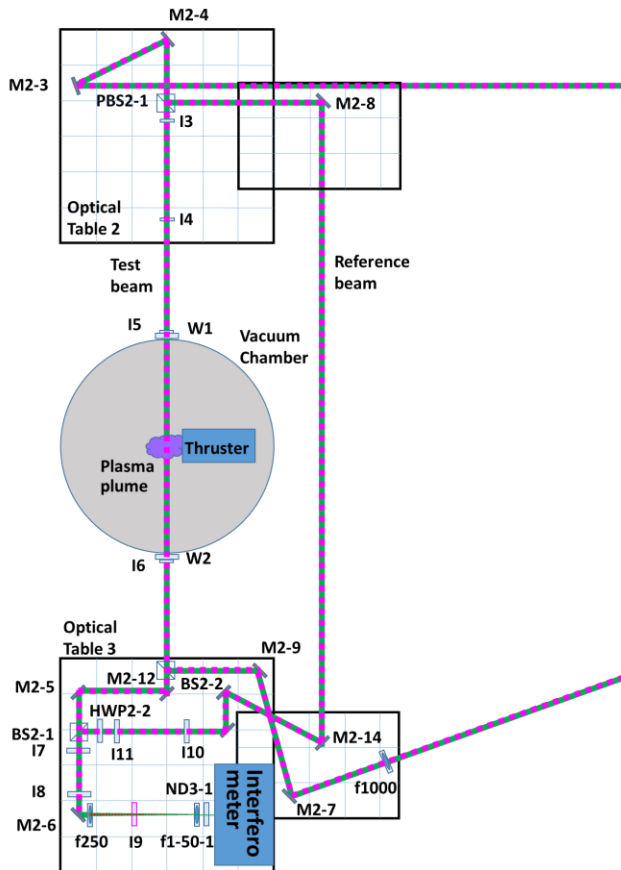



# Beam path

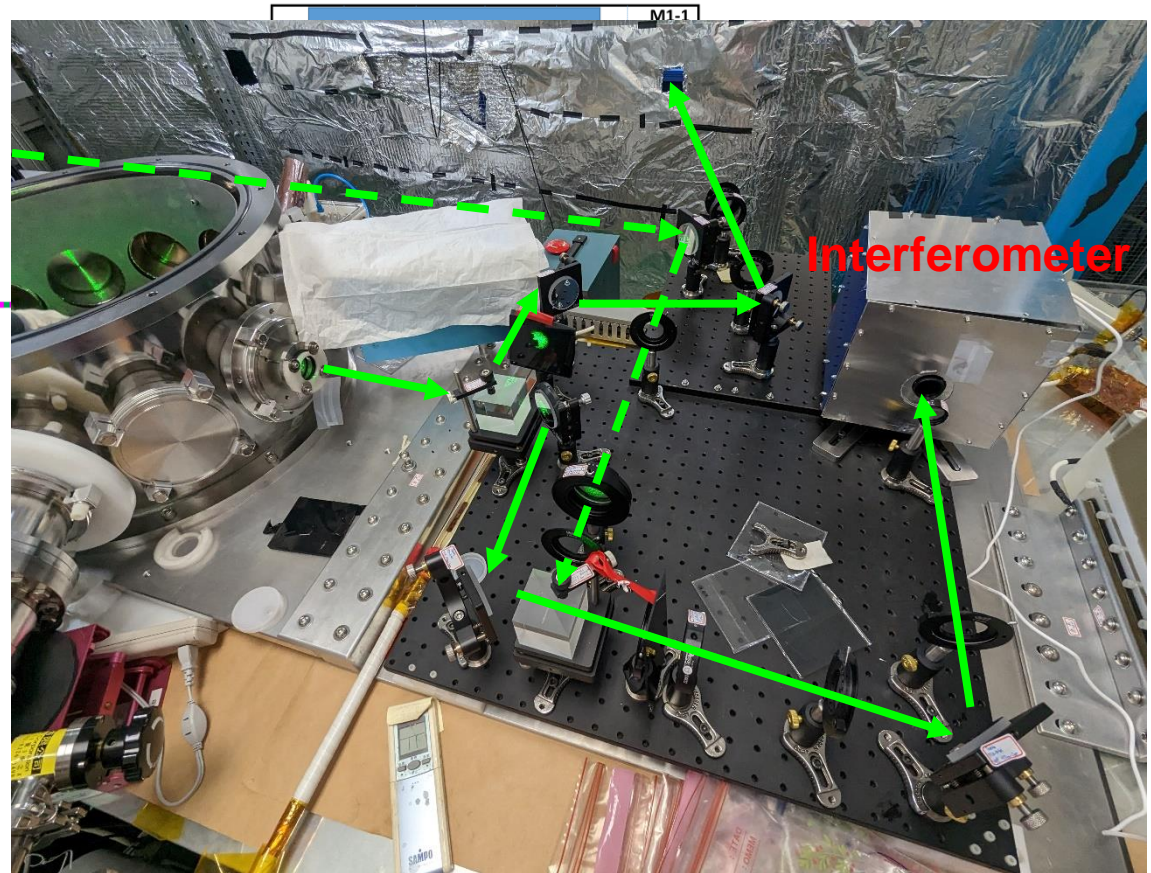
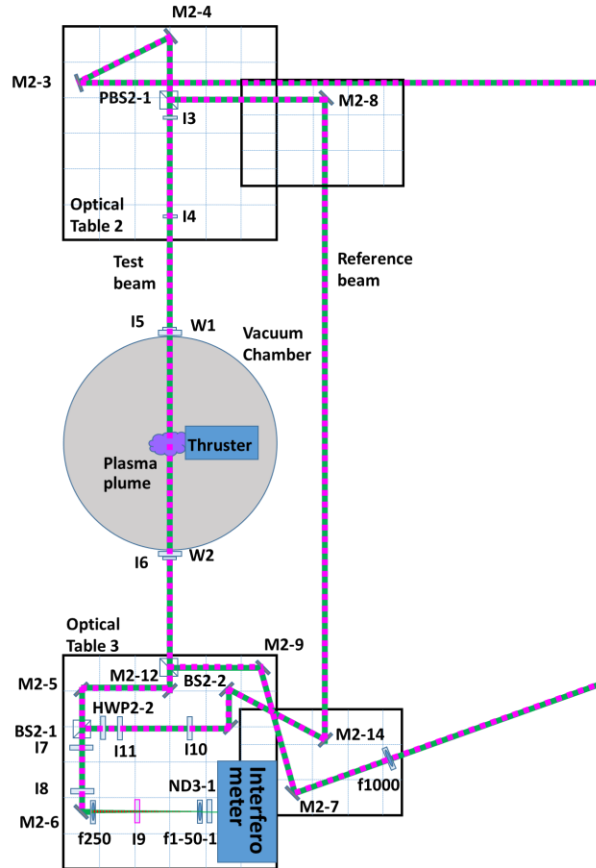

# Beam path

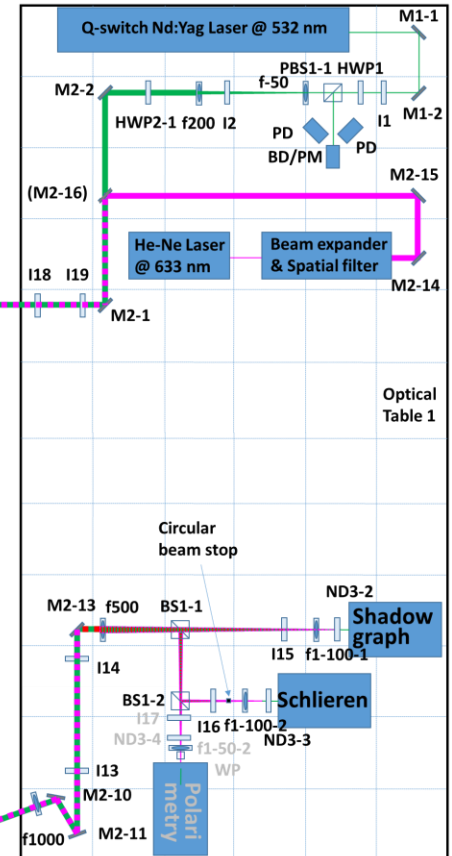
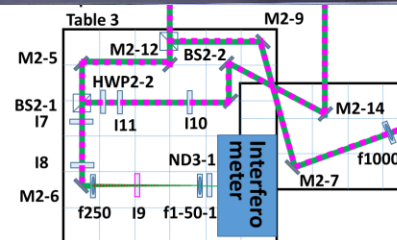
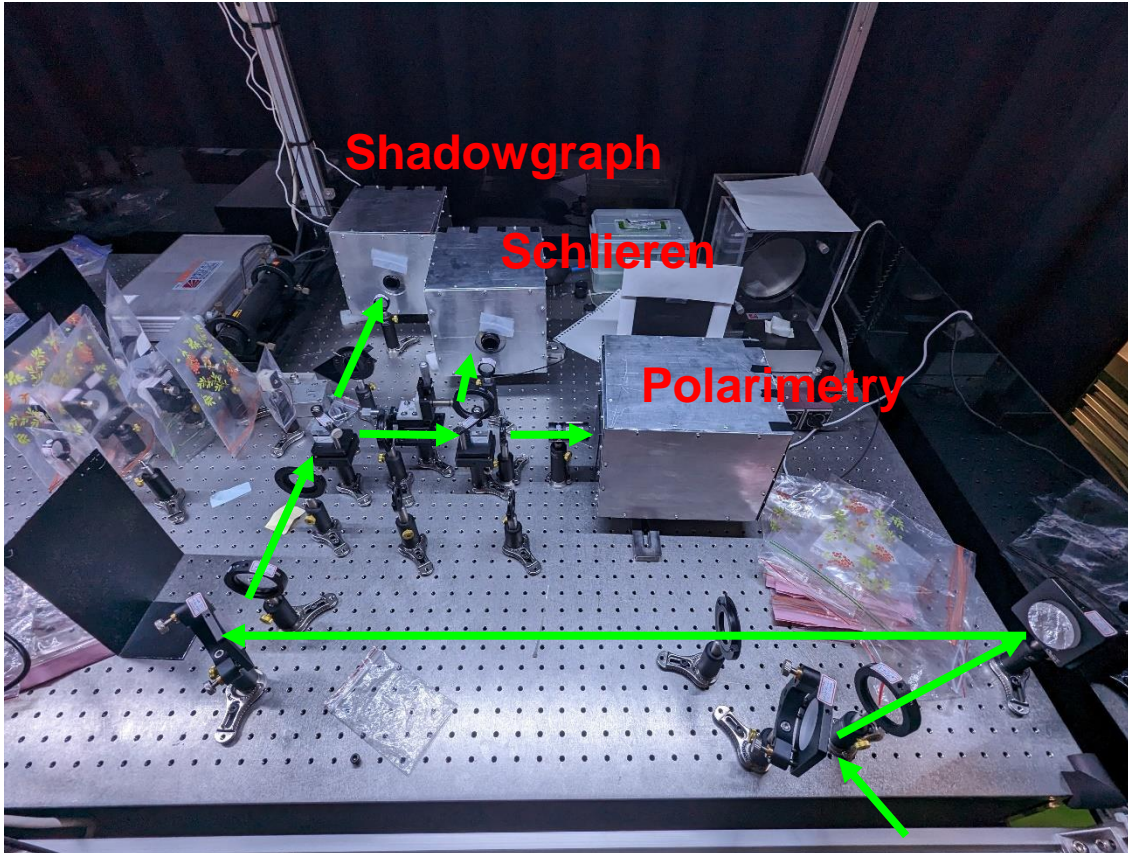



# Laboratory astrophysics: plasma jet can be generated by a conical-wire array driven by the PGS machine

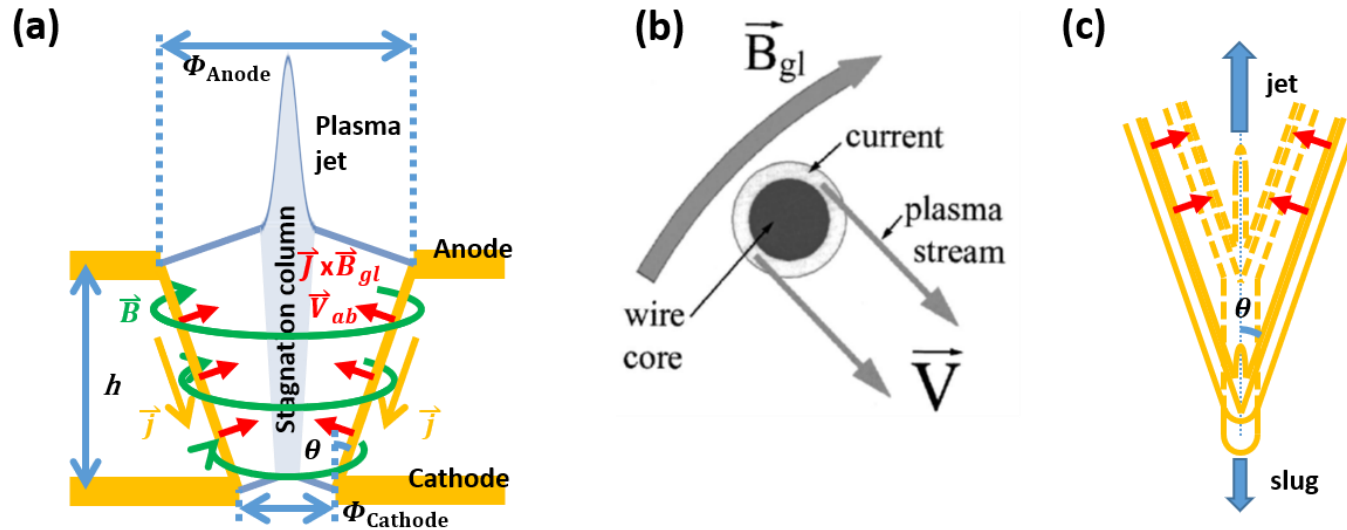

- Herbig-Haro (HH) 111 is a plasma jet driven by a compact molecular core in the L1617 cloud complex where a young star locates\*. The plasma jet in HH 111 is well collimated with the velocity of 220–330 km/s\*\*.



\*Bo Reipurth and Steve Heathcote. 50 Years of Herbig-Haro Research, pages 3–18. Springer Netherlands, Dordrecht, 1997.

\*\*Patrick Hartigan, Jon A. Morse, Bo Reipurth, Steve Heathcote, and John Bally. The Astrophysical Journal, 559(2):L157–L161, oct 2001.

\*\*\* Bo Reipurth and John Bally. Annual Review of Astronomy and Astrophysics, 39(1):403–455, sep 2001.

# Our conical-wire array consists of 4 tungsten wires with an inclination angle of $30^\circ$ with respect to the axis

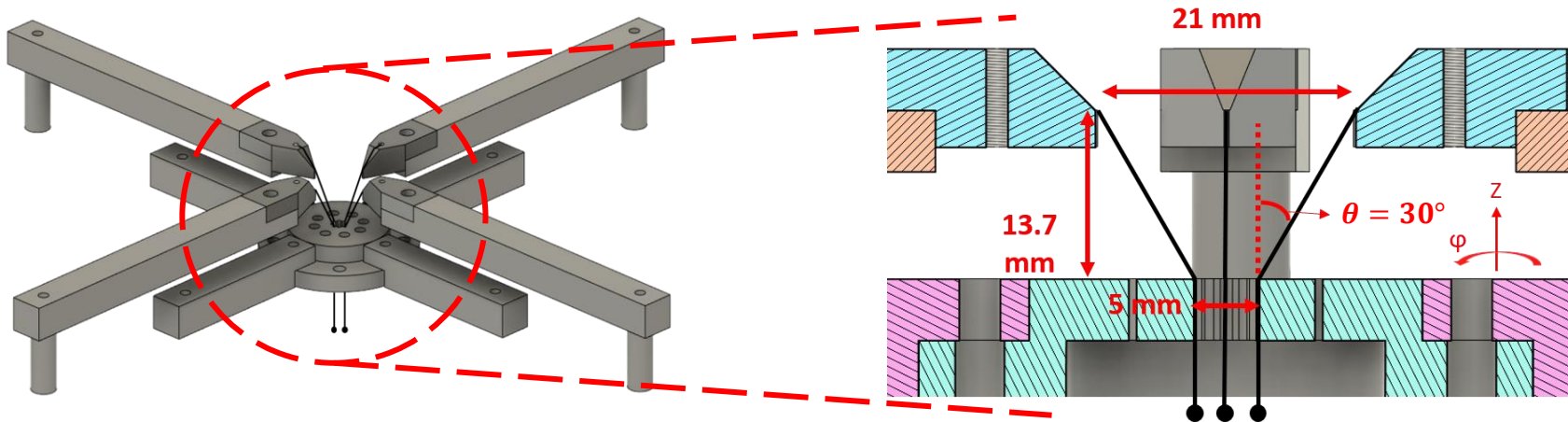

- Conical-wire array

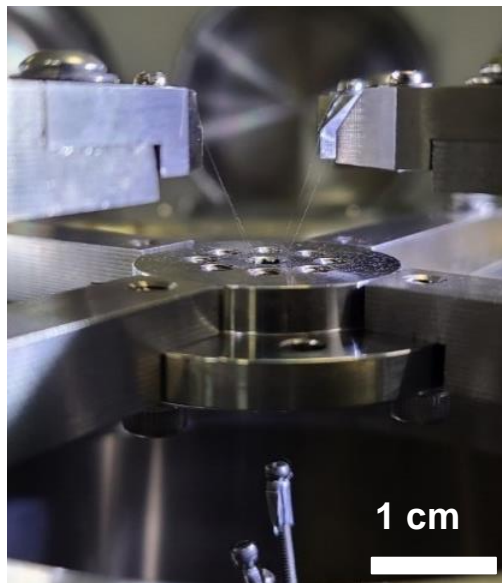
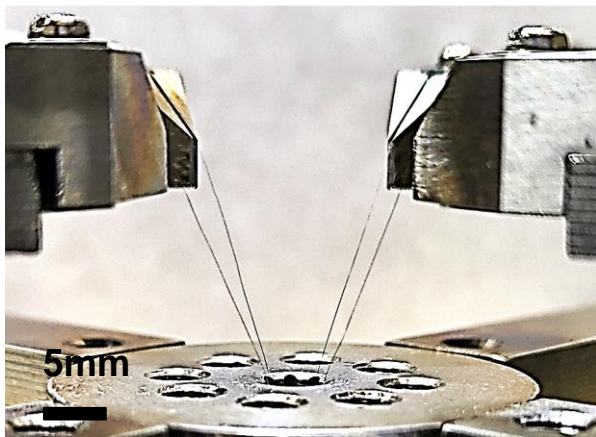

- Material : Tungsten.
- Number of wires : 4.
- Diameter :  $20 \mu\text{m}$ .

# Self-emission of the plasma jet in the UV to soft x-ray regions was captured by the pinhole camera



- Image in UV/soft x ray

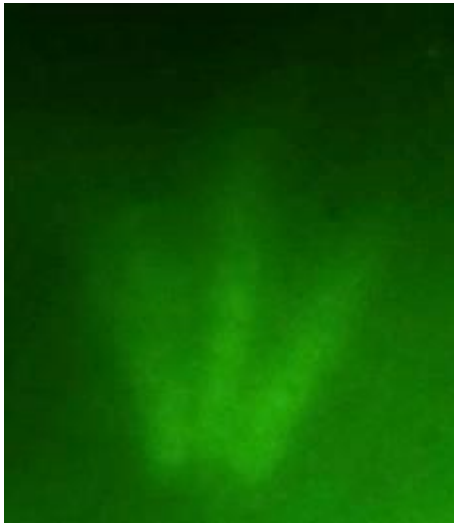

(Brightness is increased by 40 %.)

- Pinhole diameter: 0.5 mm, i.e., spatial resolution: 1 mm.

- Image in visible light

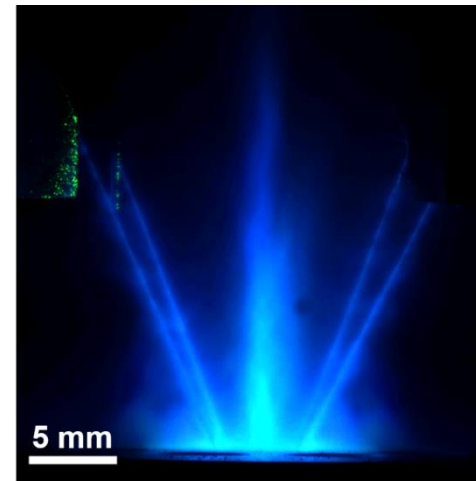

(Enhanced by scaling the intensity range linearly from 0 – 64 to 0 – 255.)



# The MCP was burned due to the higher DC voltage supply



- Image in UV/soft x ray

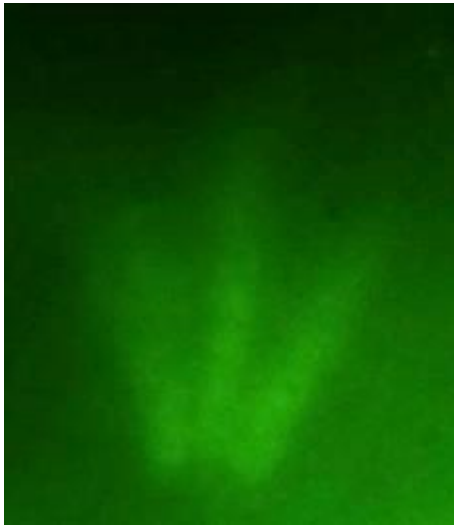

(Brightness is increased by 40 %.)



- Pinhole diameter:  
0.5 mm, i.e., spatial  
resolution: 1 mm.

# Plasma jet propagation was observed using laser diagnostics

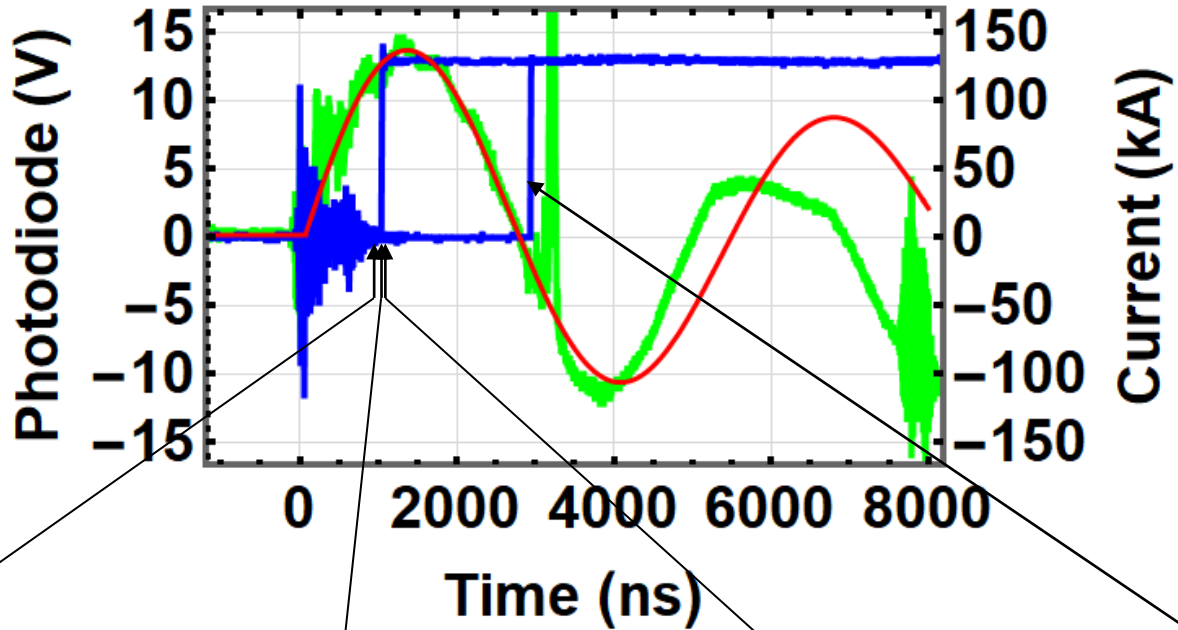

- Shadowgraph images:

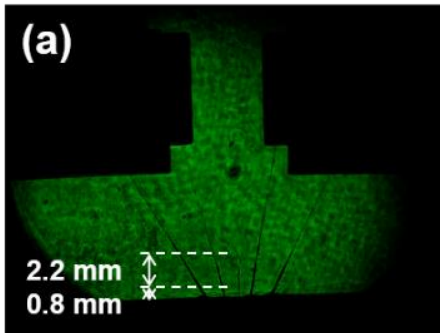

$930 \pm 20$  ns

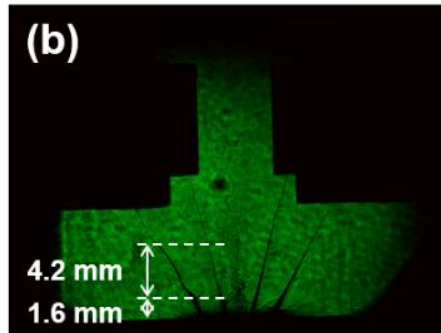

$975 \pm 2$  ns

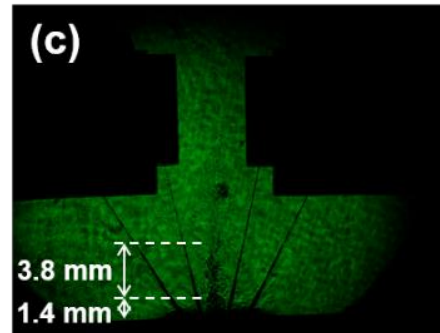

$985 \pm 3$  ns

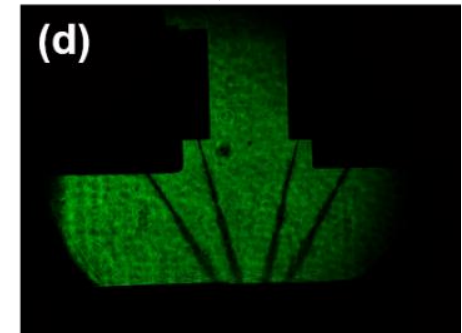

$2945 \pm 2$  ns

# Length of the plasma jet at different time was obtained by the Schlieren images at different times



- Shadowgraph images:

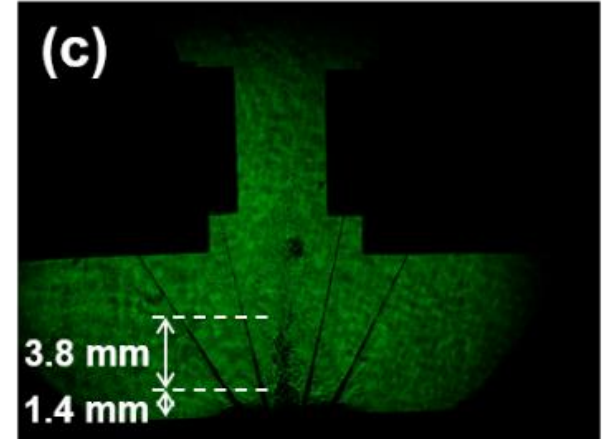
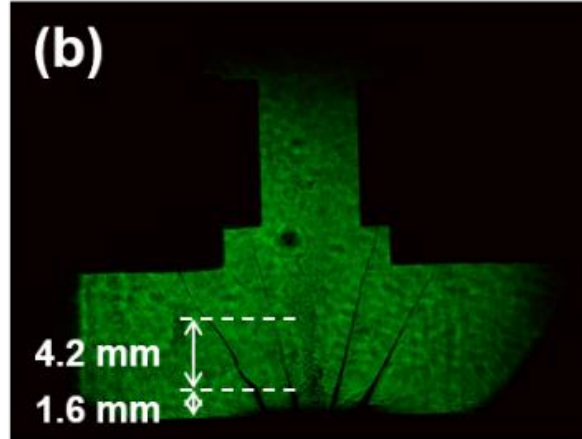
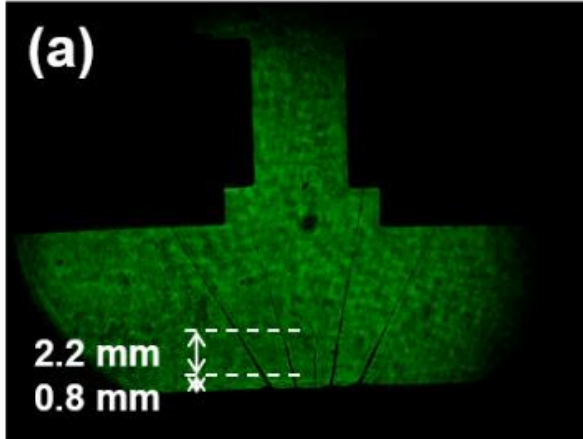

- Schlieren images:

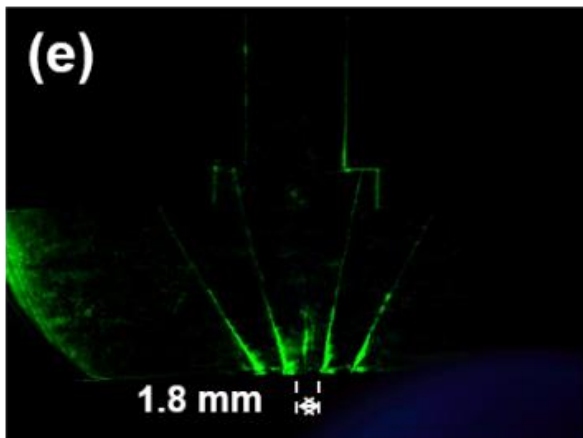

930 ± 20 ns

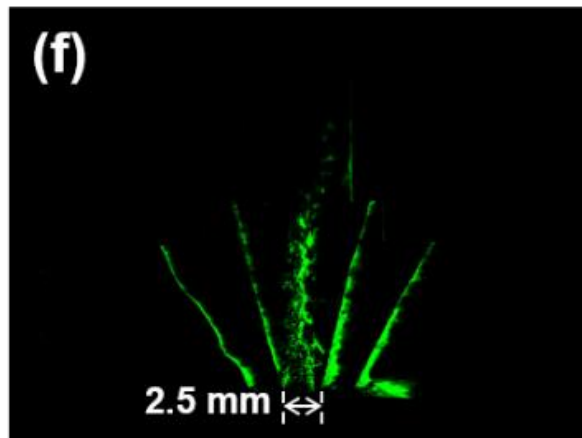

975 ± 2 ns

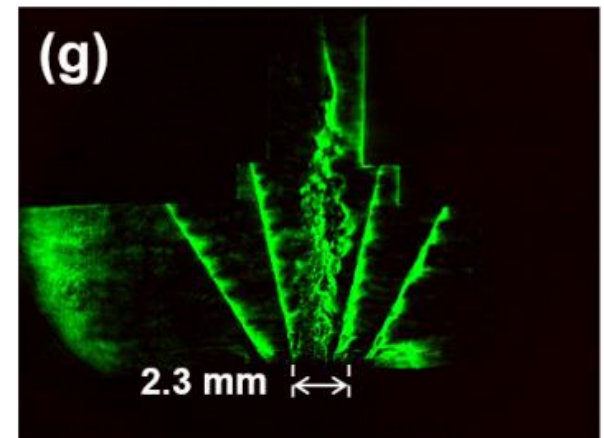

985 ± 3 ns

The measured plasma jet speed is  $170 \pm 70$  km/s with the corresponding Mach number greater than 5

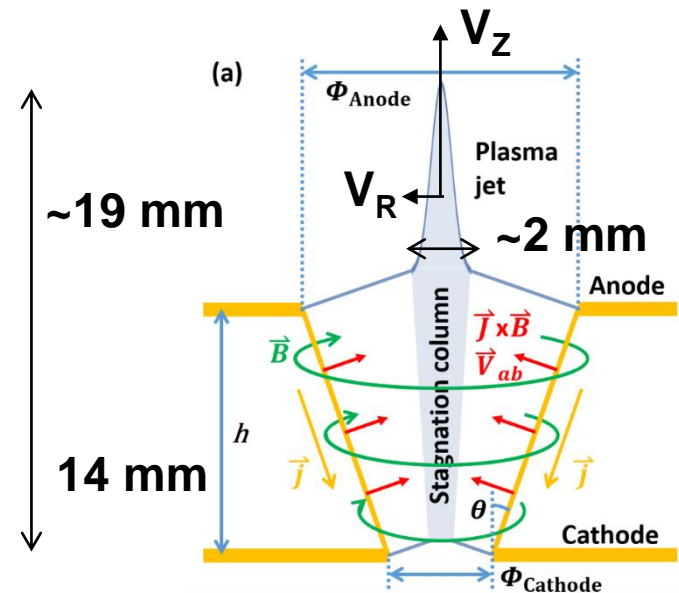
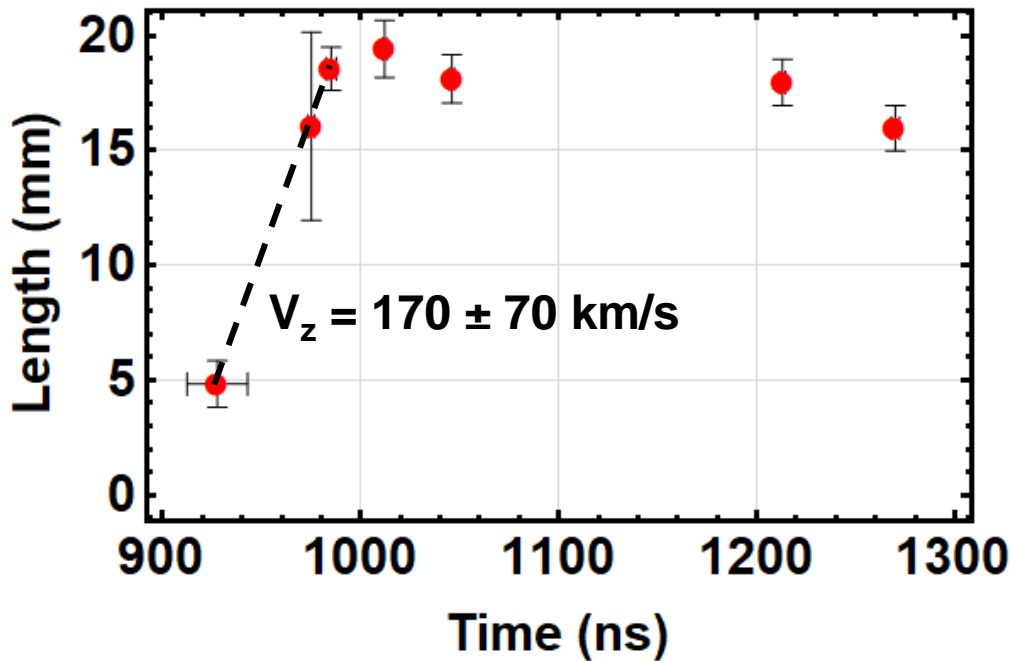

$$M = \frac{V_z}{V_R} \geq \frac{Z}{r} \approx \frac{(19 - 14) \text{ mm}}{\frac{2 \text{ mm}}{2}} = 5$$

$$V_{ab} = V_j \frac{\sin \theta}{1 + \cos \theta} = 50 \pm 20 \text{ km/s}$$

# Can a rotating plasma disk be formed? To be continue...

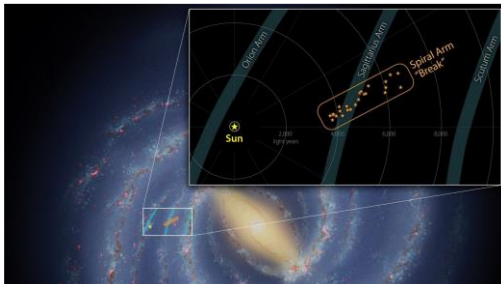
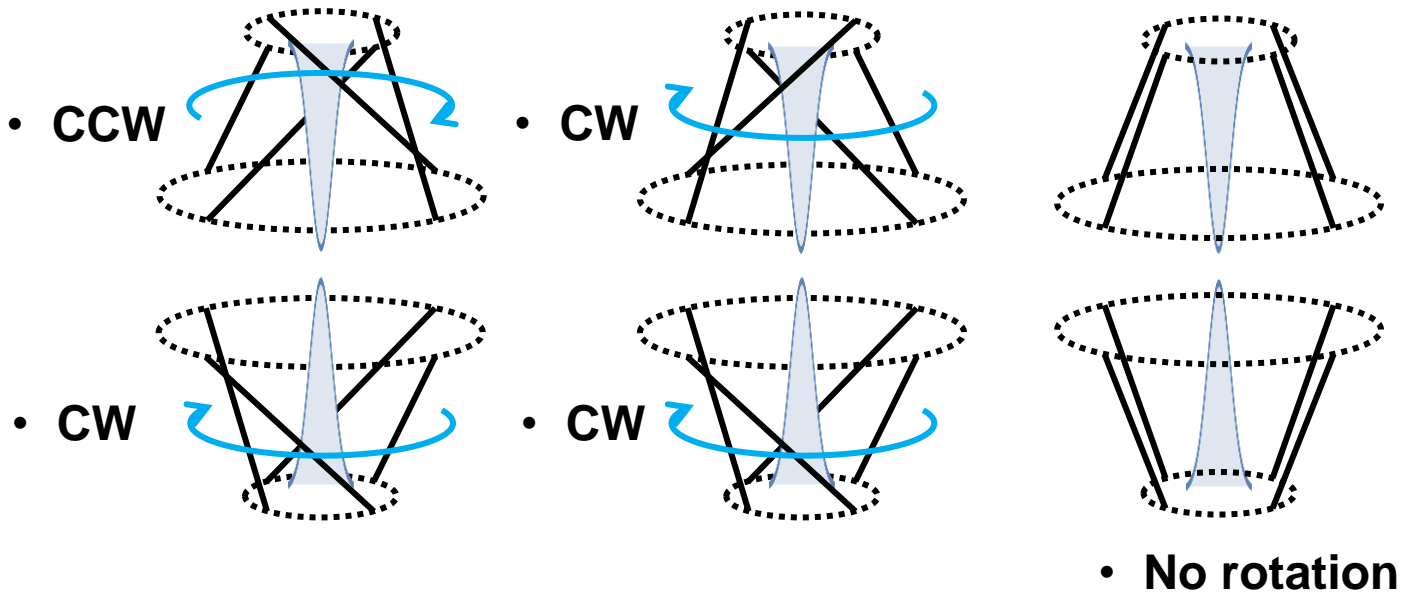

- **Astronomers Find a ‘Break’ in One of the Milky Way’s Spiral Arms.**



# Plasma disk can be formed when two head-on plasma jets collide with each other



- Astronomers Find a 'Break' in One of the Milky Way's Spiral Arms.

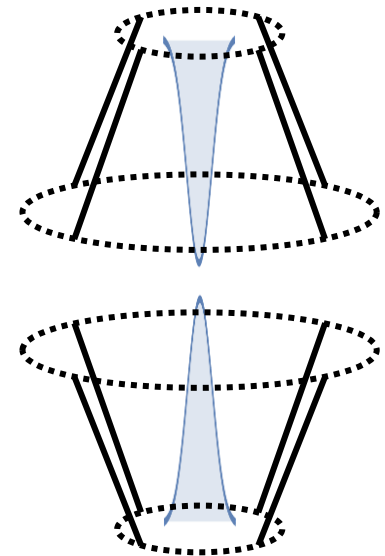
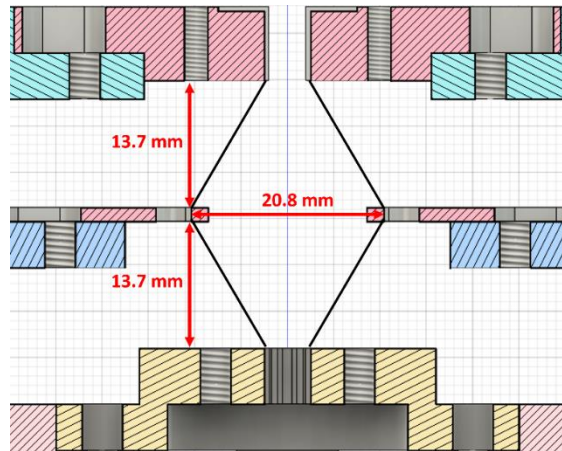
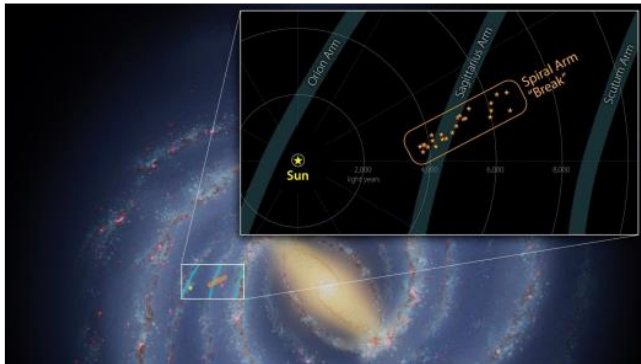

# A plasma disk with a height of $\sim 0.68$ mm and a width of $\sim 7.51$ mm was generated $\sim 0.15$ mm above the middle plane



- Schlieren image:
- Time-integrated image:

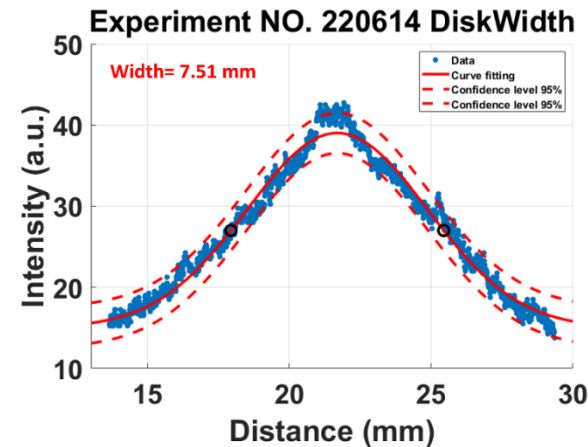
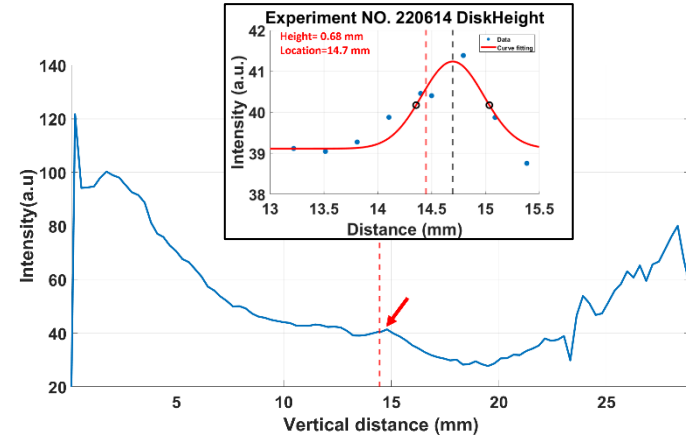
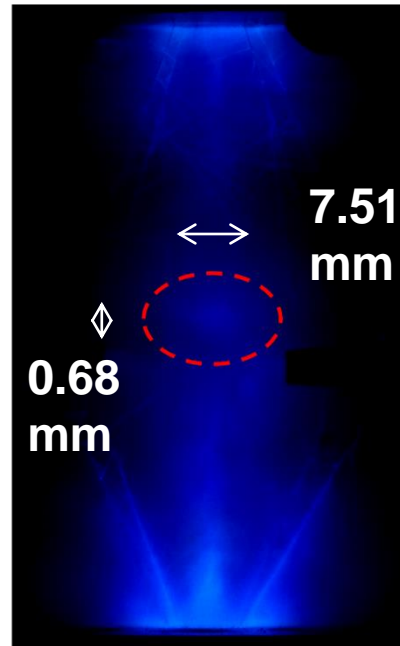
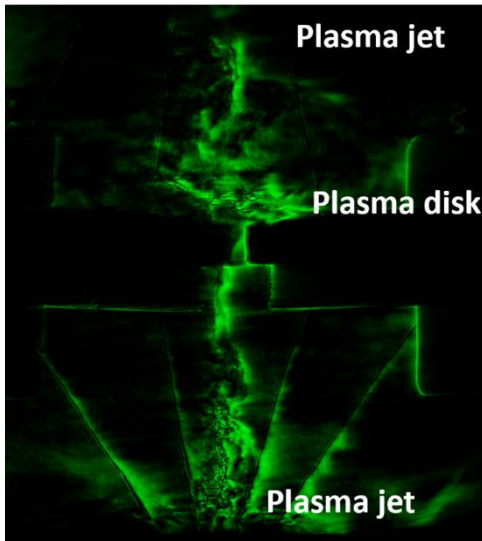

# Plasma disk can be formed when two head-on plasma jets collide with each other



## Schlieren

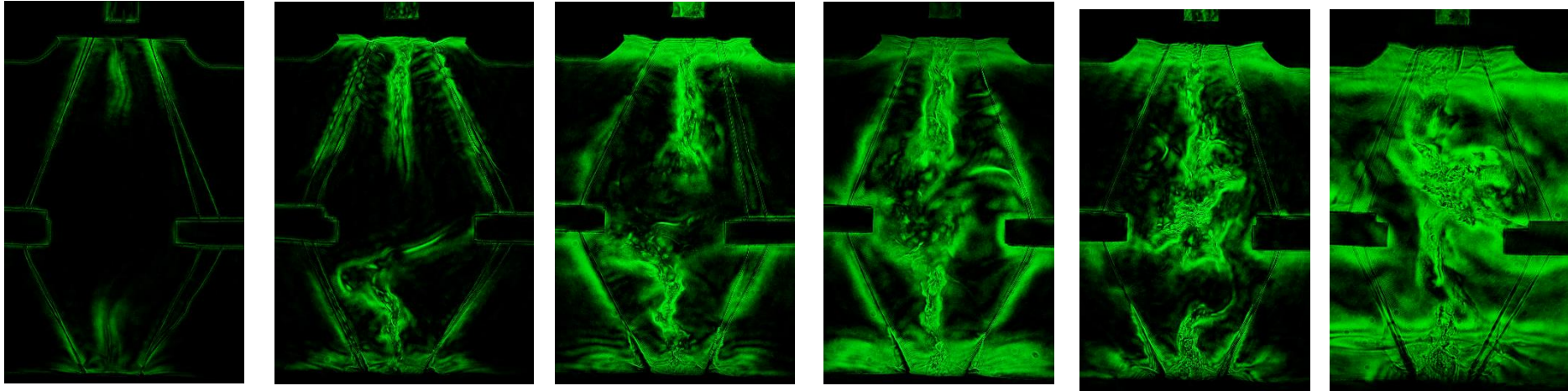

## Interferometer

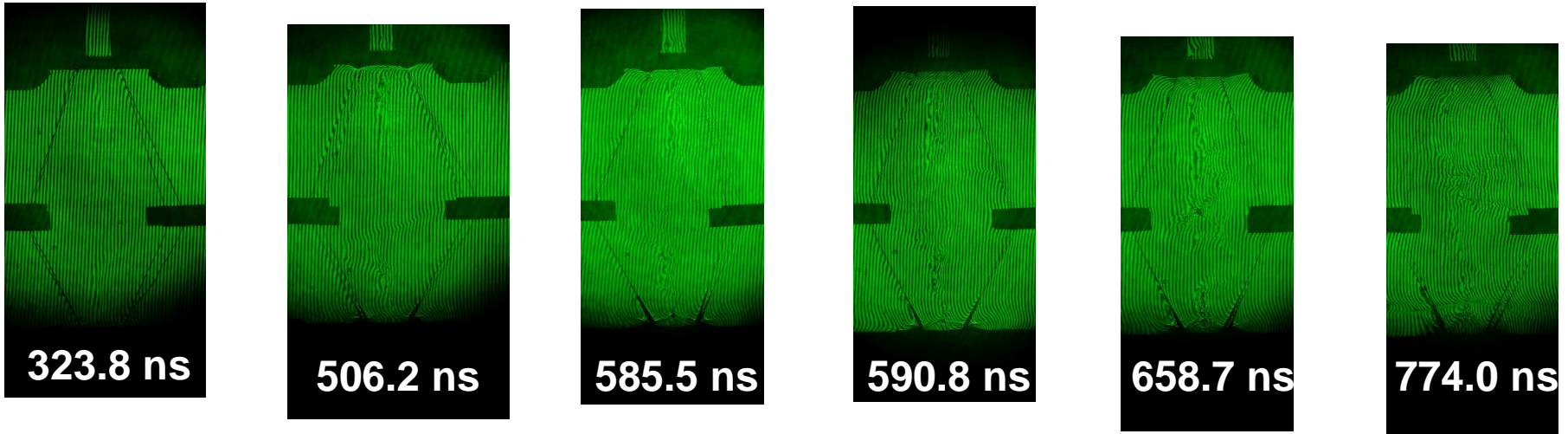



# The plasma disk with a number density of $\sim 10^{18} \text{ cm}^{-3}$ was generated



## Schlieren

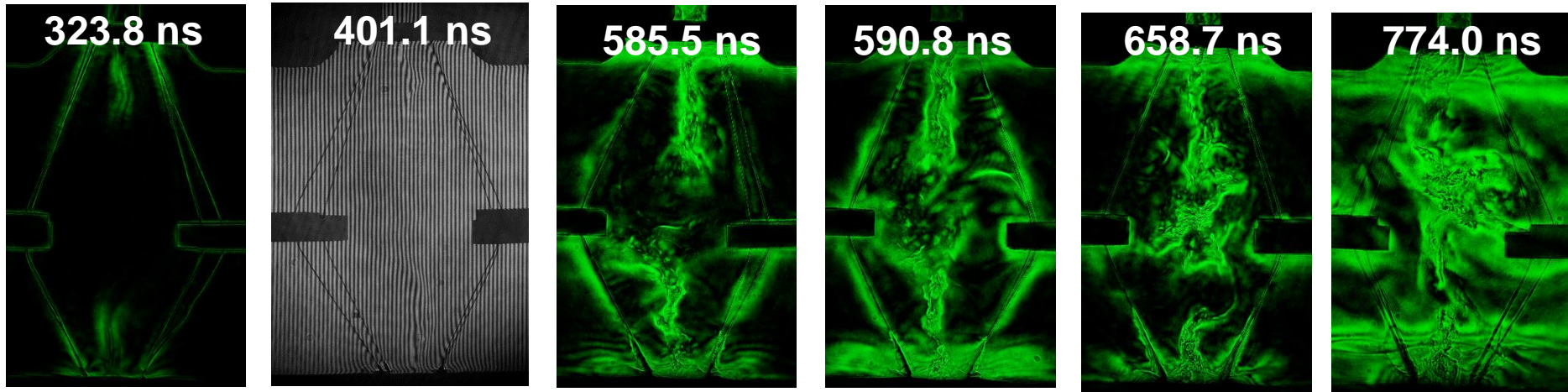

## Interferometer

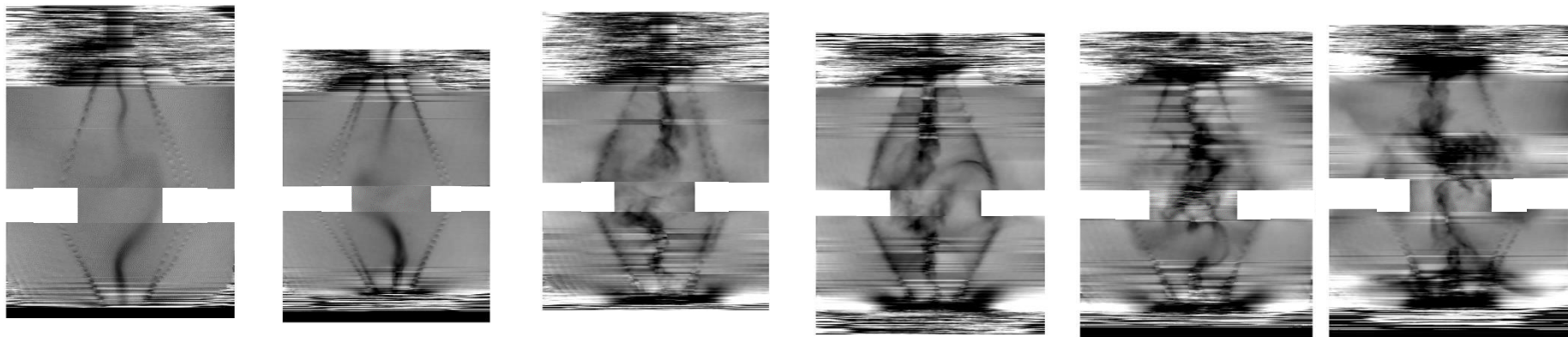

$$-2\pi \sim 2\pi \Rightarrow 0 \sim 4.2 \times 10^{17} \text{ cm}^{-2}$$

$$\Rightarrow 8.4 \times 10^{17} \text{ cm}^{-3} \text{ for } L = 5\text{mm}$$



# What if we twist the conical-wire array?



- **Non-rotation**

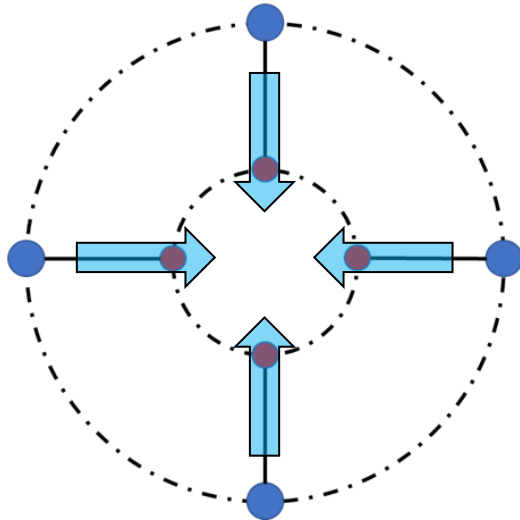

- **Clockwise 45°**

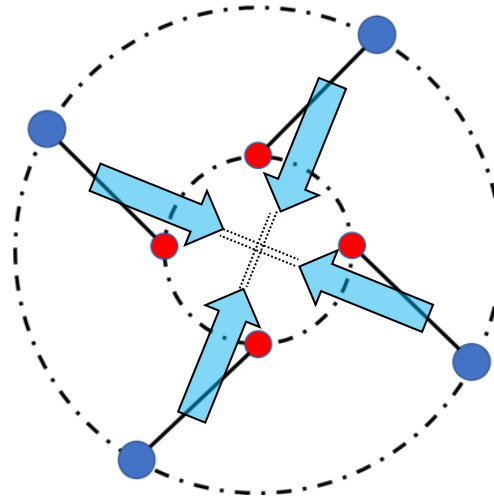

- **CCW 45°**

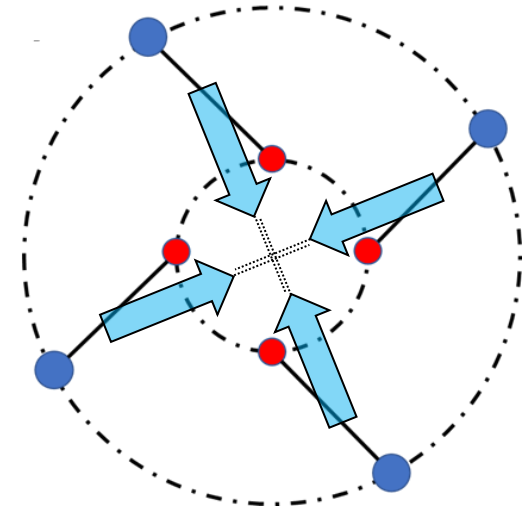



# The plasma jet is a bright spot from the top view



- **Non-rotation**

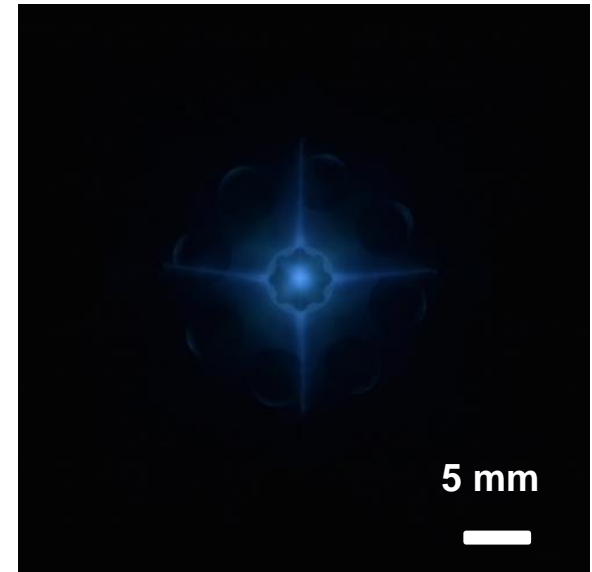
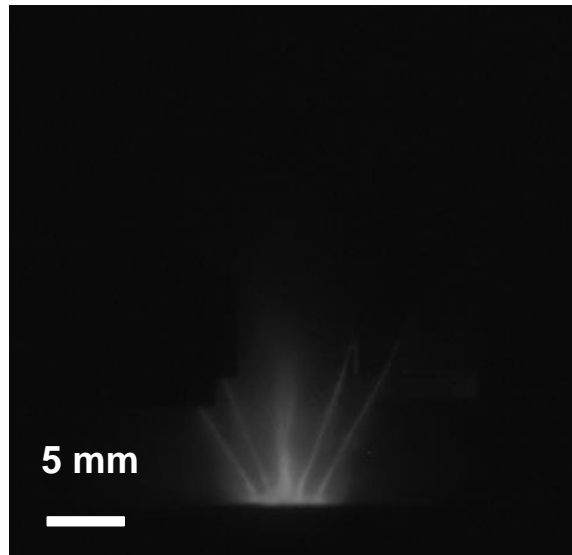
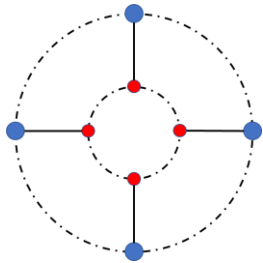

# Hollow plasma jets were generated when the conical-wire arrays were twisted



- **Clockwise 30 °**

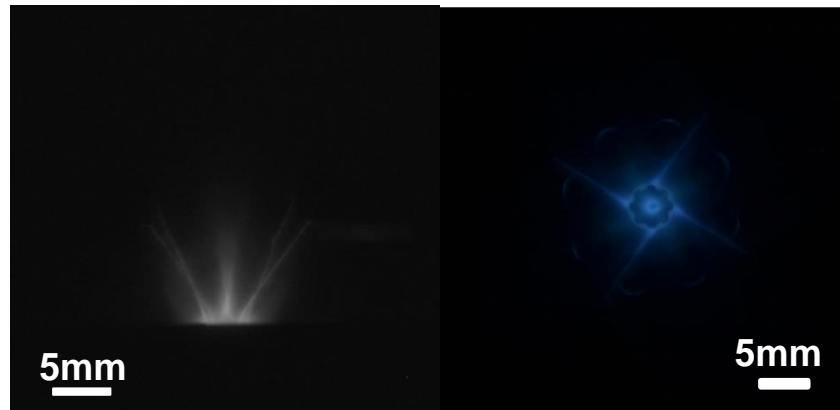
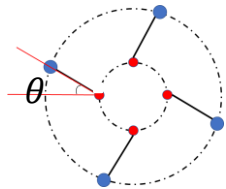

- **Counter clockwise 30 °**

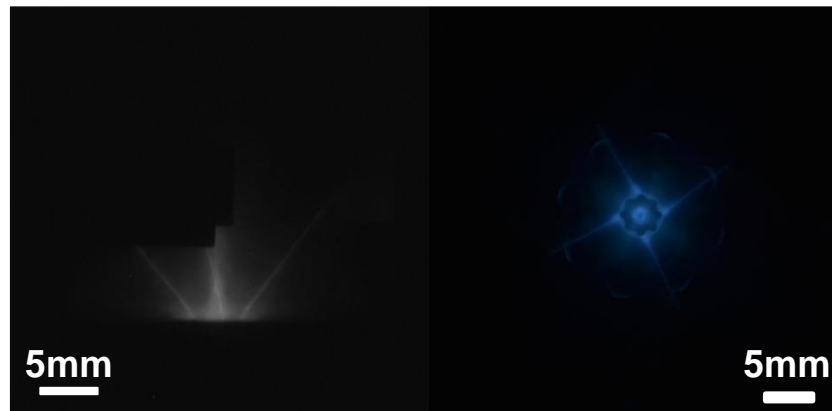
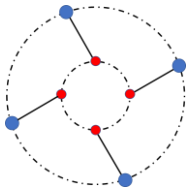

# The hollow region at the center was due to angular momentum conservation of the in-coming plasma flow

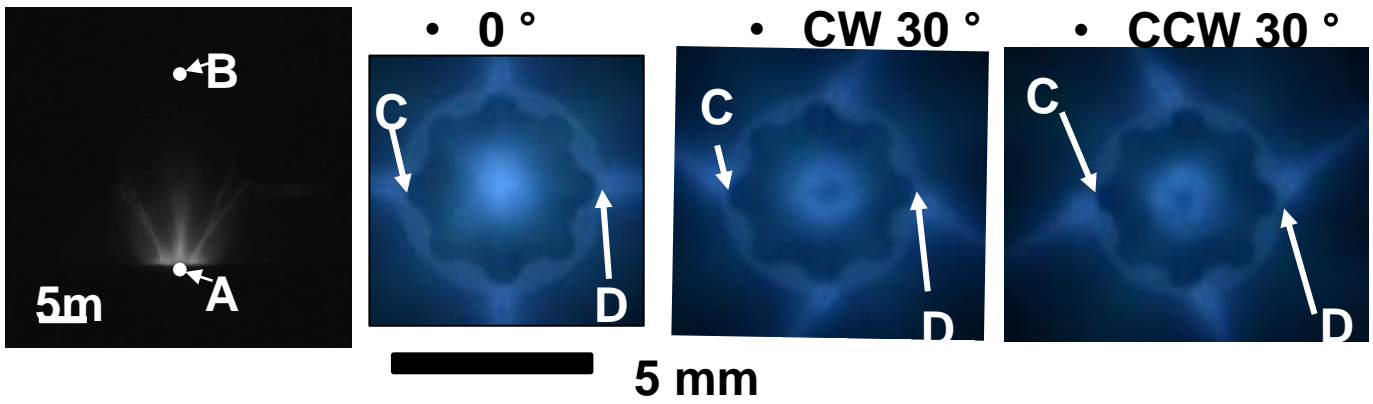
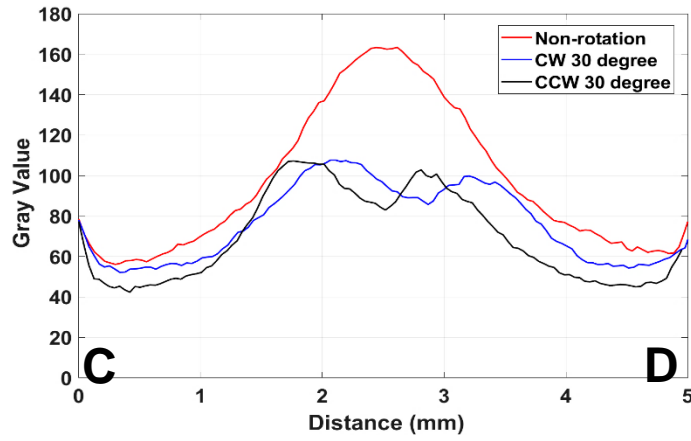
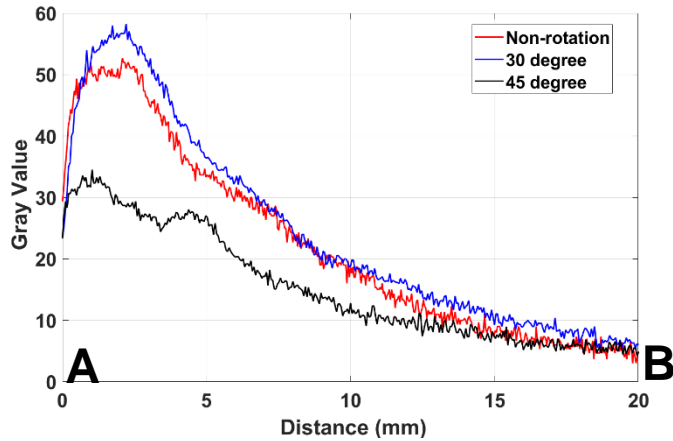

# A “tornado” is generated by the twisted conical-wire array

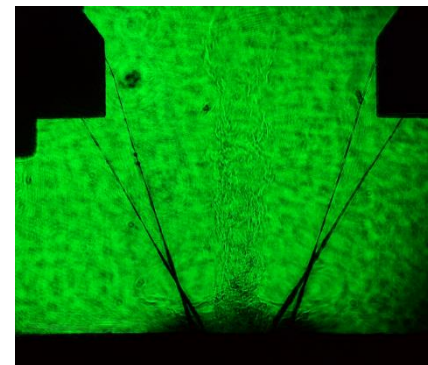
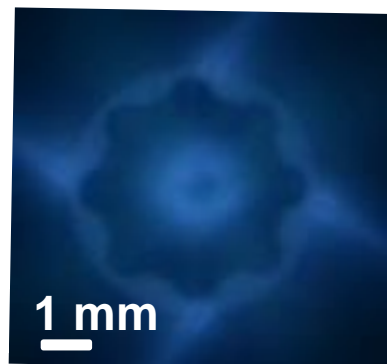
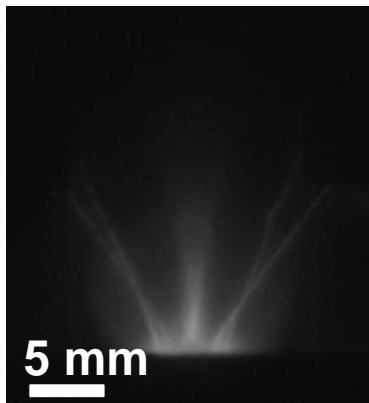
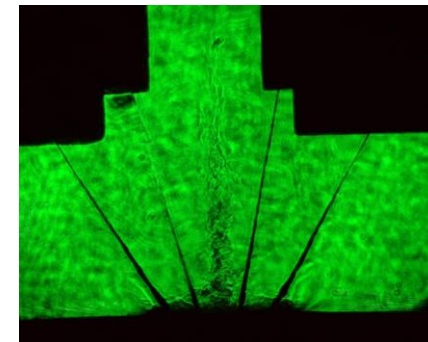
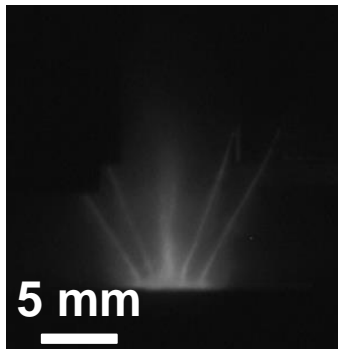

# A “tornado” is generated by the twisted conical-wire array

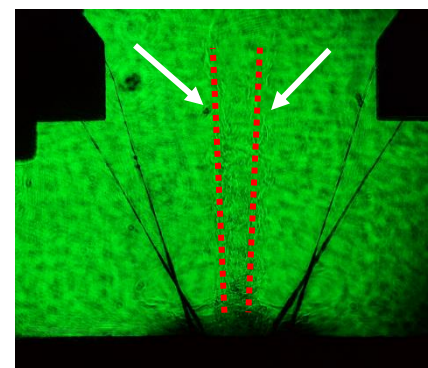
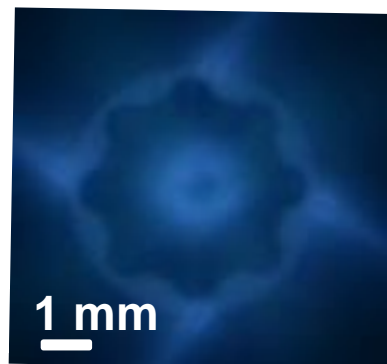
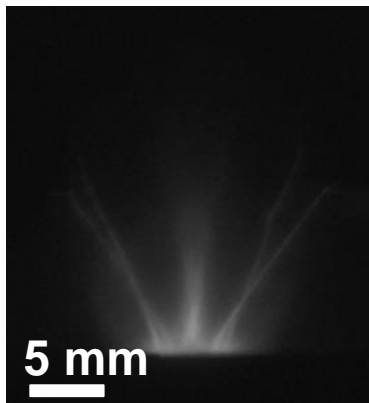
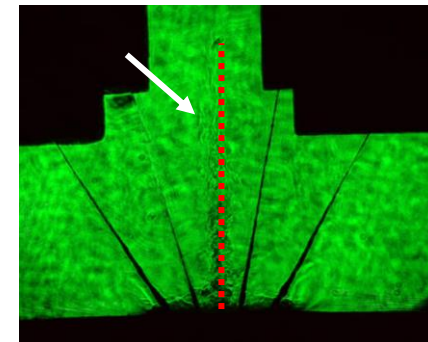
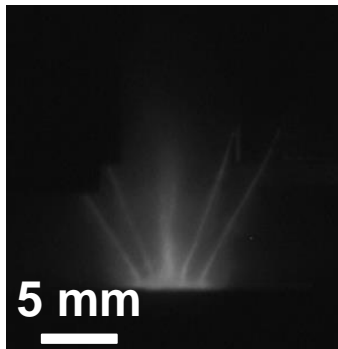



# High energy density plasma (HEDP) is the regime where the pressure is greater than 0.1 T Pa (1 Mbar)

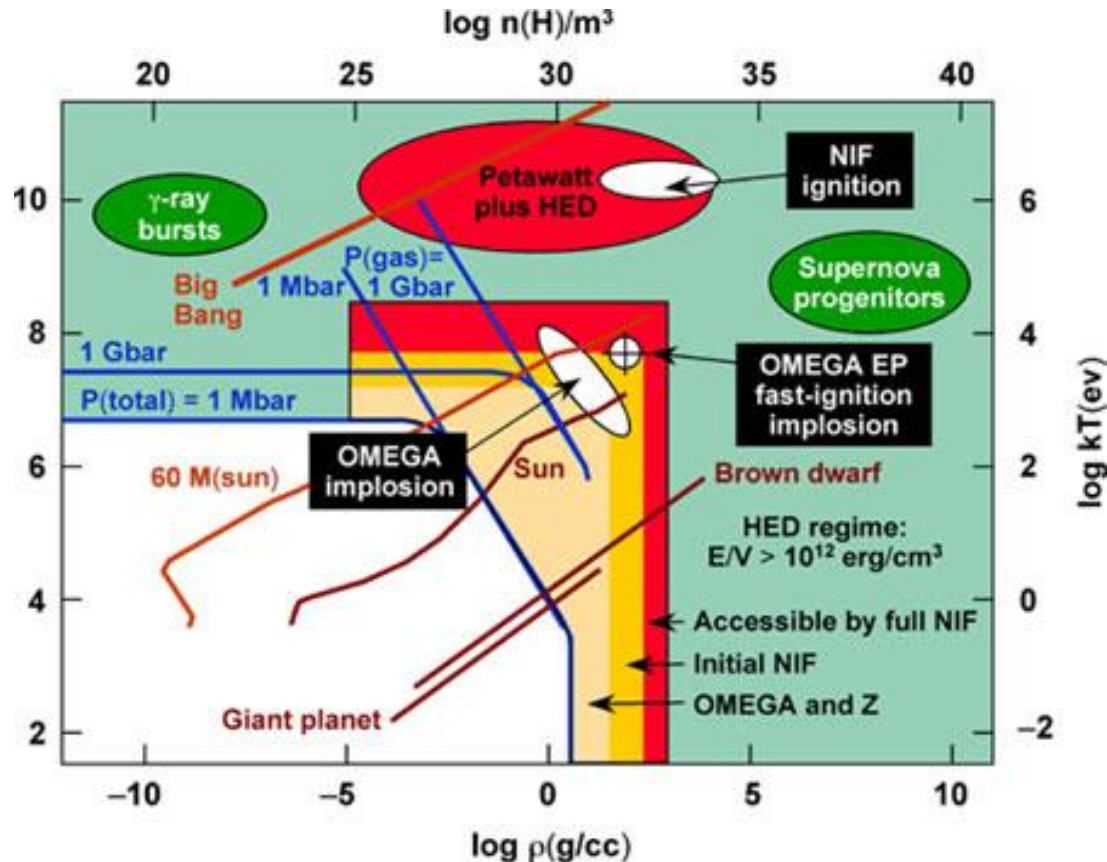

- The energy density of HEDP regime is higher than 1 kJ of energy per  $10 \text{ mm}^3$ .

# Softer material can be compressed to higher density



- **Compression of a baseball**



- **Compression of a tennis ball**

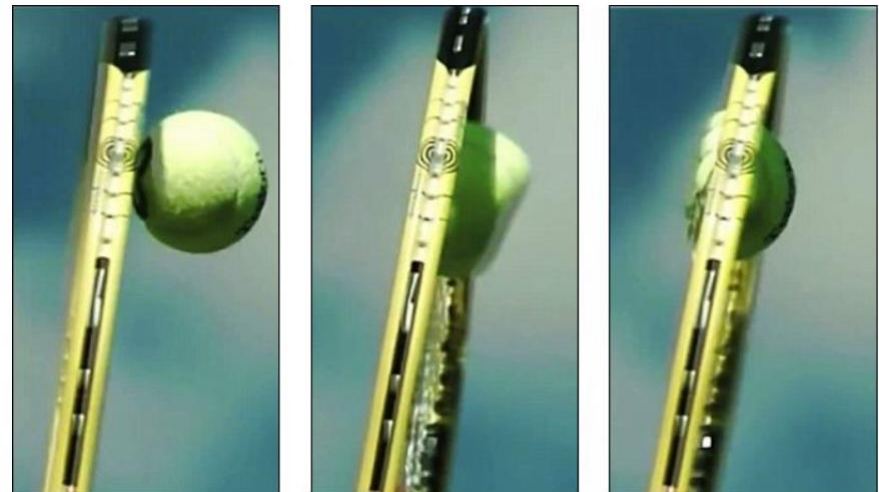

<https://www.youtube.com/watch?v=uxlldMoAwbY>

<https://newsghana.com.gh/wimbledon-slow-motion-video-of-how-a-tennis-ball-turns-to-goo-after-serve/>

# A shock is formed due to the increasing sound speed of a compressed gas/plasma



- Wave in the ocean:

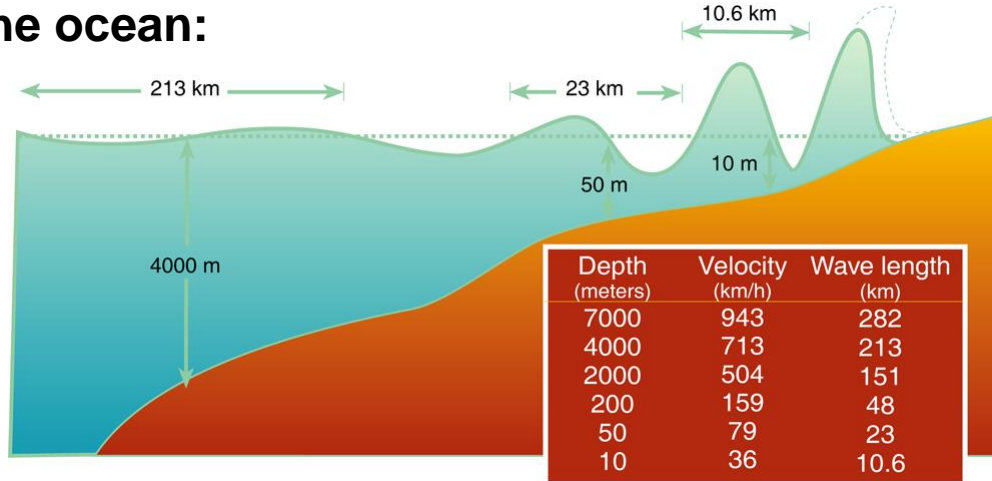

- Acoustic/compression wave driven by a piston:

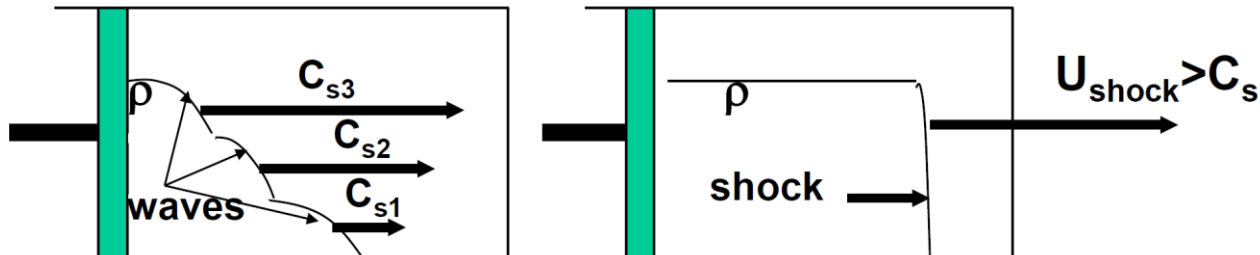

$$c_s \sim \sqrt{\gamma \frac{p}{\rho}} \sim \sqrt{\frac{\alpha \rho^{5/3}}{\rho}} \sim \sqrt{\alpha} \rho^{1/3}$$

# A wave with small amplitude (perturbation) travels with the sound speed



$$\frac{\partial \rho}{\partial t} + \nabla \cdot (\rho \vec{u}) = 0$$

$$\rho \left( \frac{\partial \vec{u}}{\partial t} + \vec{u} \cdot \nabla \vec{u} \right) = -\nabla p + \rho \vec{f}$$

$$\frac{\partial}{\partial t} \left( \frac{\rho u^2}{2} + \rho \varepsilon \right) + \nabla \cdot \vec{u} \left[ \left( \frac{\rho u^2}{2} + \rho \varepsilon \right) + p \right] = \rho \vec{f} \cdot \vec{u} - \nabla \cdot \vec{q}$$

$$\rho = \rho_0 + \Delta \rho \quad p = p_0 + \Delta p \quad \vec{u} = \vec{u}_0 + \Delta \vec{u} \equiv (u_0 + \Delta u) \hat{x} \equiv \Delta u \hat{x}$$

$$\frac{\partial \Delta \rho}{\partial t} = -\rho_0 \frac{\partial \Delta u}{\partial x} \quad \rho_0 \frac{\partial \Delta u}{\partial t} = -\frac{\partial p}{\partial x} = -\left( \frac{\partial p}{\partial \rho} \right)_s \frac{\partial \Delta \rho}{\partial x} \equiv -c_s^2 \frac{\partial \Delta \rho}{\partial x}$$

$$\frac{\partial^2 \Delta \rho}{\partial t^2} = c_s^2 \frac{\partial^2 \Delta \rho}{\partial x^2} \quad \begin{aligned} \Delta \rho &= \Delta \rho(x \pm c_s t) \\ \Delta p &= \Delta p(x \pm c_s t) \\ \Delta u &= \Delta u(x \pm c_s t) \end{aligned} \quad c_s \sim \sqrt{\gamma \frac{p}{\rho}} \sim \sqrt{\frac{\alpha \rho^{5/3}}{\rho}} \sim \sqrt{\alpha} \rho^{1/3}$$

# A wave is distorted when the sound speed is not a constant

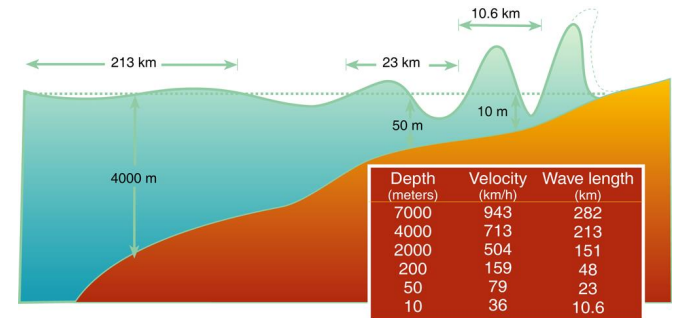
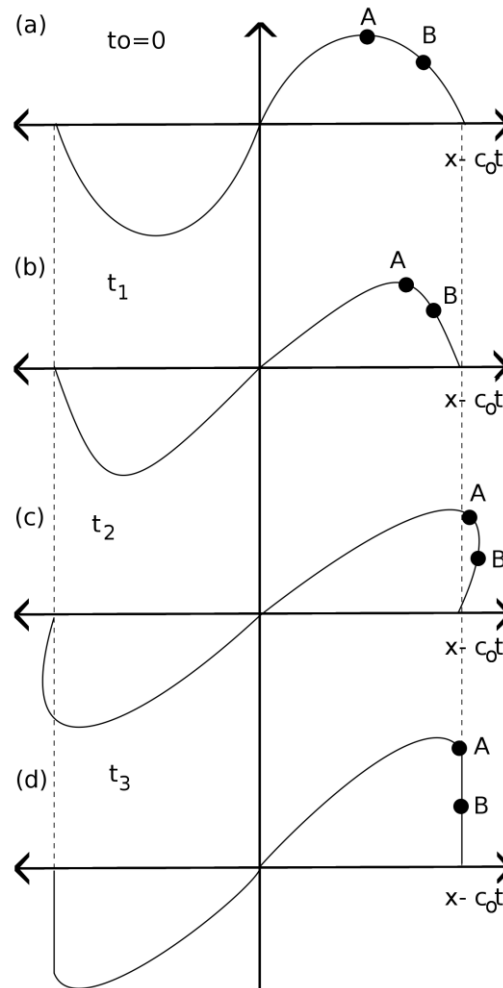
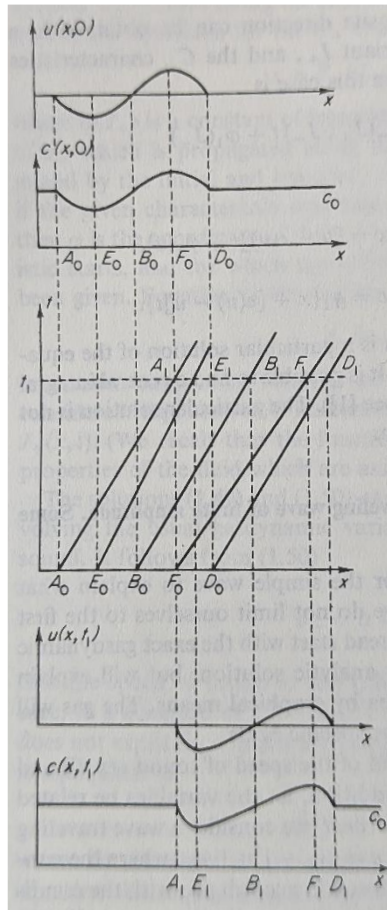

• A shock wave is formed when a discontinuity is formed.

$$c_s \sim \sqrt{\alpha \rho}^{1/3}$$

Y. B. Zel'dovich & Y. P. Raizer, Physics of shock waves and high-temperature hydrodynamic phenomena  
 Maria Alejandra Barrios Garcia, PhD Thesis, U of Rochester, 2010  
<http://neamtic.ioc-unesco.org/tsunami-info/the-cause-of-tsunamis>



# A shock is formed when characteristics merge while a rarefaction wave is formed when characteristics spread out

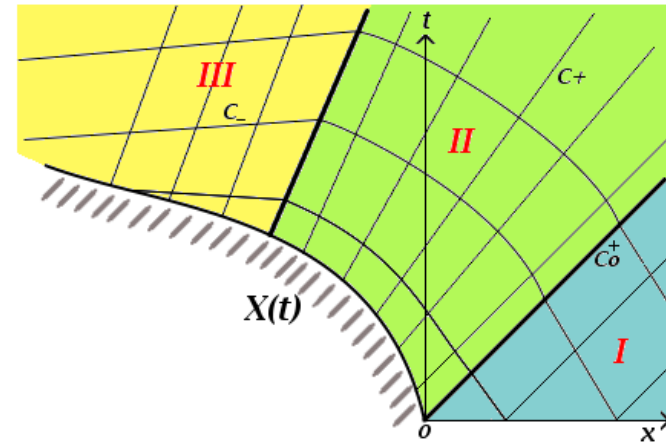
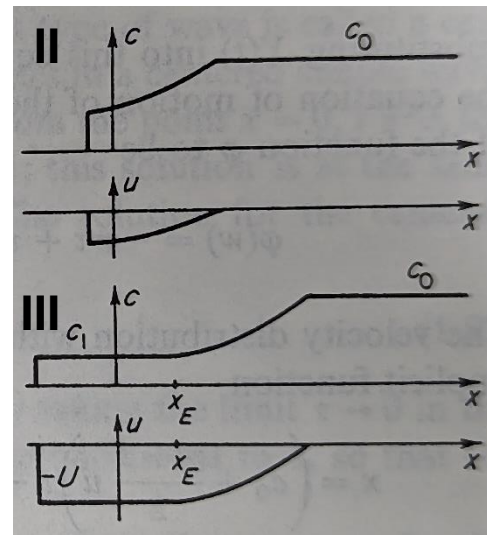
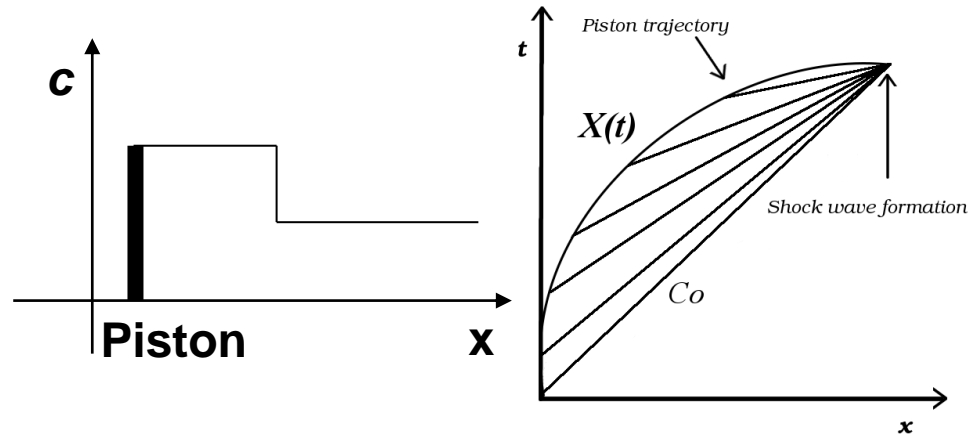
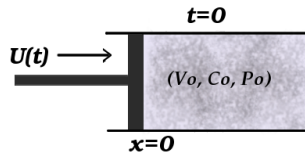

# A shock or a rarefaction wave may be formed depending on the driving force from the piston

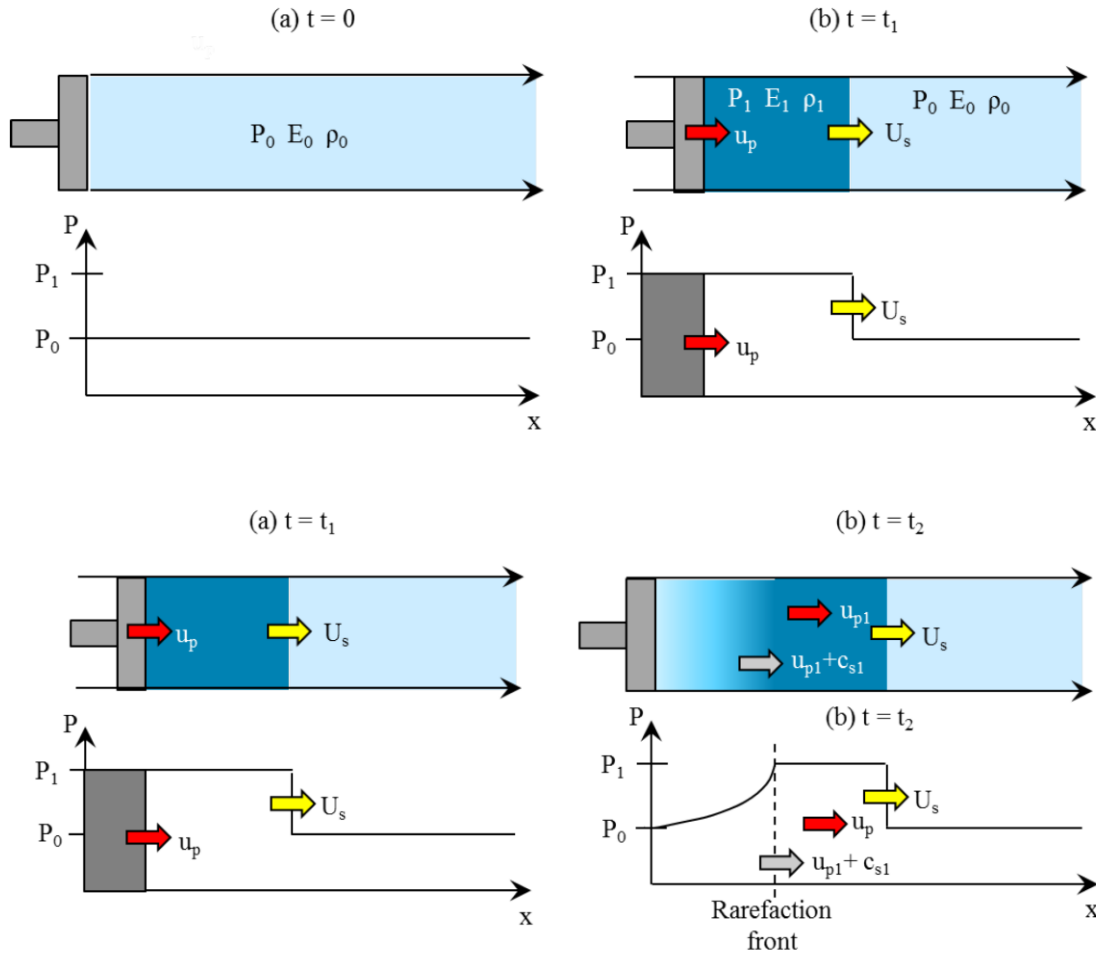

- Show simulations.

# Mass, momentum, and energy is conserved across the shock front

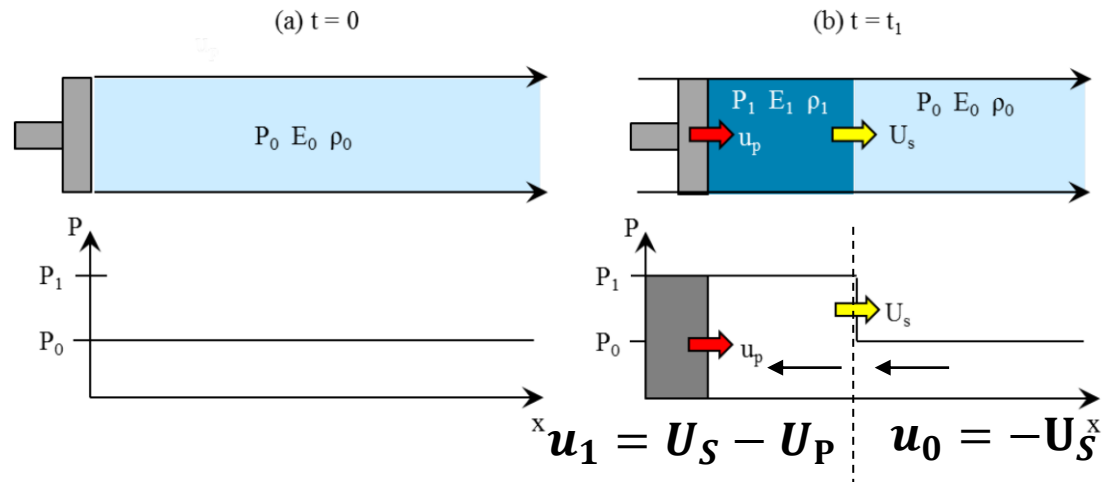

$$\frac{\partial \rho}{\partial t} + \nabla \cdot (\rho \vec{u}) = 0$$

$$\rho \left( \frac{\partial \vec{u}}{\partial t} + \vec{u} \cdot \nabla \vec{u} \right) = -\nabla p + \rho \vec{f}$$

$$\frac{\partial}{\partial t} \left( \frac{\rho u^2}{2} + \rho \epsilon \right) + \nabla \cdot \vec{u} \left[ \left( \frac{\rho u^2}{2} + \rho \epsilon \right) + p \right] = \rho \vec{f} \cdot \vec{u} - \nabla \cdot \vec{q}$$

$$\rho_1 u_1 = \rho_0 u_0$$

$$p_1 + \rho_1 u_1^2 = p_0 + \rho_0 u_0^2$$

$$\epsilon_1 + \frac{p_1}{\rho_1} + \frac{u_1^2}{2} = \epsilon_0 + \frac{p_0}{\rho_0} + \frac{u_0^2}{2}$$

# The Hugoniot equations relate the pre- and post-shock conditions via the particle velocity ( $U_p$ ) and shock velocity ( $U_s$ )

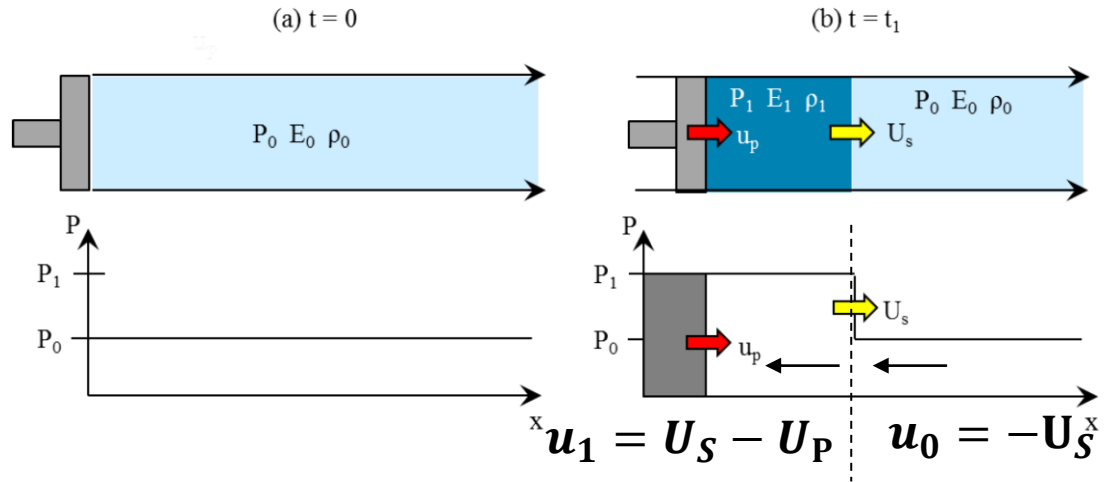

$$\rho_1 u_1 = \rho_0 u_0$$

$$p_1 + \rho_1 u_1^2 = p_0 + \rho_0 u_0^2$$

$$\epsilon_1 + \frac{p_1}{\rho_1} + \frac{u_1^2}{2} = \epsilon_0 + \frac{p_0}{\rho_0} + \frac{u_0^2}{2}$$

$$\rho_0 U_s = \rho_1 (U_s - U_p)$$

$$p_1 - p_0 = \rho_0 U_s U_p$$

$$u_0 \left[ \frac{\rho_0 u_0^2}{2} + \rho_0 \epsilon_0 + p_0 \right] = u_1 \left[ \frac{\rho_1 u_1^2}{2} + \rho_1 \epsilon_1 + p_1 \right]$$

$$p_0 u_0 - p_1 u_1 = \rho_1 u_1 \left( \epsilon_1 + \frac{u_1^2}{2} \right) - \rho_0 u_0 \left( \epsilon_0 + \frac{u_0^2}{2} \right) = \rho_0 u_0 \left[ \left( \epsilon_1 + \frac{u_1^2}{2} \right) - \left( \epsilon_0 + \frac{u_0^2}{2} \right) \right]$$

# The Hugoniot equations relate the pre- and post-shock conditions via the particle velocity ( $U_p$ ) and shock velocity ( $U_s$ ) – cont.

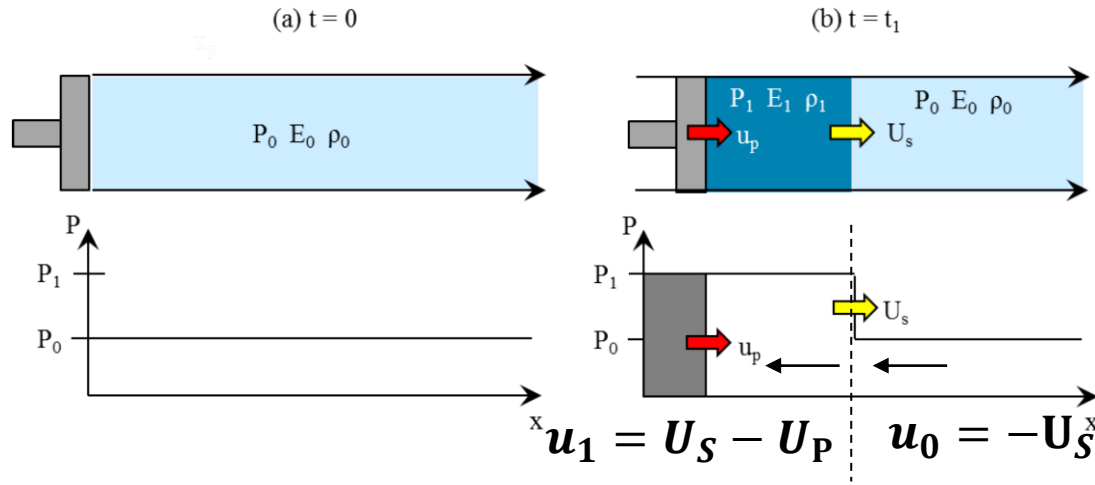

$$\rho_0 U_s = \rho_1 (U_s - U_p)$$

$$p_1 - p_0 = \rho_0 U_s U_p$$

$$u_0 \left[ \frac{\rho_0 u_0^2}{2} + \rho_0 \epsilon_0 + p_0 \right] = u_1 \left[ \frac{\rho_1 u_1^2}{2} + \rho_1 \epsilon_1 + p_1 \right]$$

$$p_0 u_0 - p_1 u_1 = \rho_1 u_1 \left( \epsilon_1 + \frac{u_1^2}{2} \right) - \rho_0 u_0 \left( \epsilon_0 + \frac{u_0^2}{2} \right) = \rho_0 u_0 \left[ \left( \epsilon_1 + \frac{u_1^2}{2} \right) - \left( \epsilon_0 + \frac{u_0^2}{2} \right) \right]$$

$$\text{Let } V_{1,2} \equiv \frac{1}{\rho_{1,2}}$$

$$u_0^2 = V_0^2 \frac{p_1 - p_0}{V_0 - V_1}$$

$$u_1^2 = V_1^2 \frac{p_1 - p_0}{V_0 - V_1}$$

$$\epsilon_1 - \epsilon_0 = \frac{1}{2} (p_0 + p_1) (V_0 - V_1)$$



# The density is only compressed by a limited amount even in a strong shock

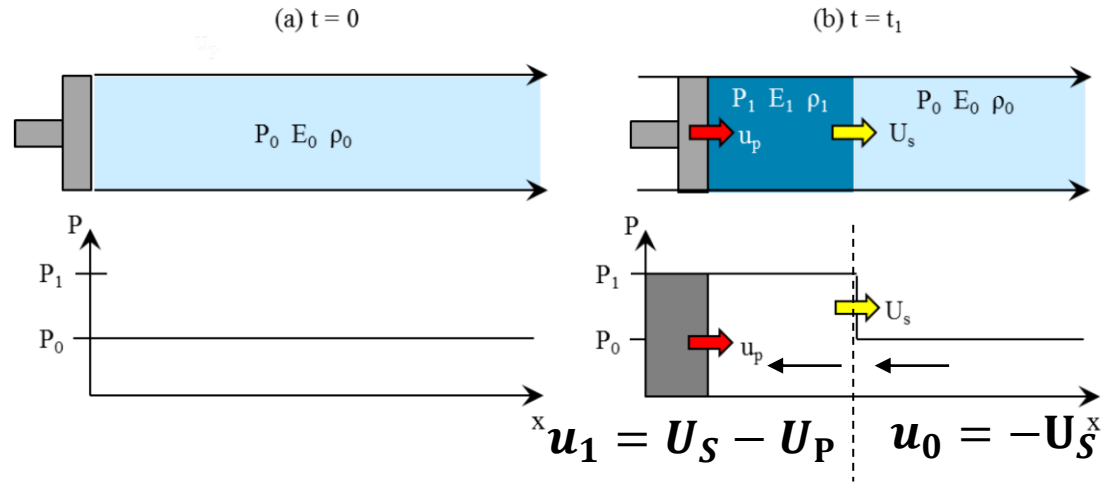

$$V_{0,1} \equiv \frac{1}{\rho_{0,1}} \quad u_0^2 = V_0^2 \frac{p_1 - p_0}{V_0 - V_1} \quad u_1^2 = V_1^2 \frac{p_1 - p_0}{V_0 - V_1} \quad \epsilon_1 - \epsilon_0 = \frac{1}{2} (p_0 + p_1) (V_0 - V_1)$$

$$\frac{\rho_1}{\rho_0} = \frac{V_0}{V_1} = \frac{p_1(\gamma + 1) + p_0(\gamma - 1)}{p_1(\gamma - 1) + p_0(\gamma + 1)} \sim \frac{\gamma + 1}{\gamma - 1} \left( \text{for } \frac{p_1}{p_0} \gg 1 \right) \sim 4 \left( \text{for } \gamma = \frac{5}{3} \right)$$

$$u_0^2 = \frac{V_0}{2} [(\gamma - 1)p_0 + (\gamma + 1)p_1] = \frac{p_0}{\rho_0} \frac{(\gamma + 1)p_1/p_0 + (\gamma - 1)}{2}$$

$$u_1^2 = \frac{V_0}{2} \frac{[(\gamma + 1)p_0 + (\gamma - 1)p_1]^2}{(\gamma - 1)p_0 + (\gamma + 1)p_1}$$

The Hugoniot curve is a curve on the  $p, V$  diagram passing through the initial state  $p_0, V_0$

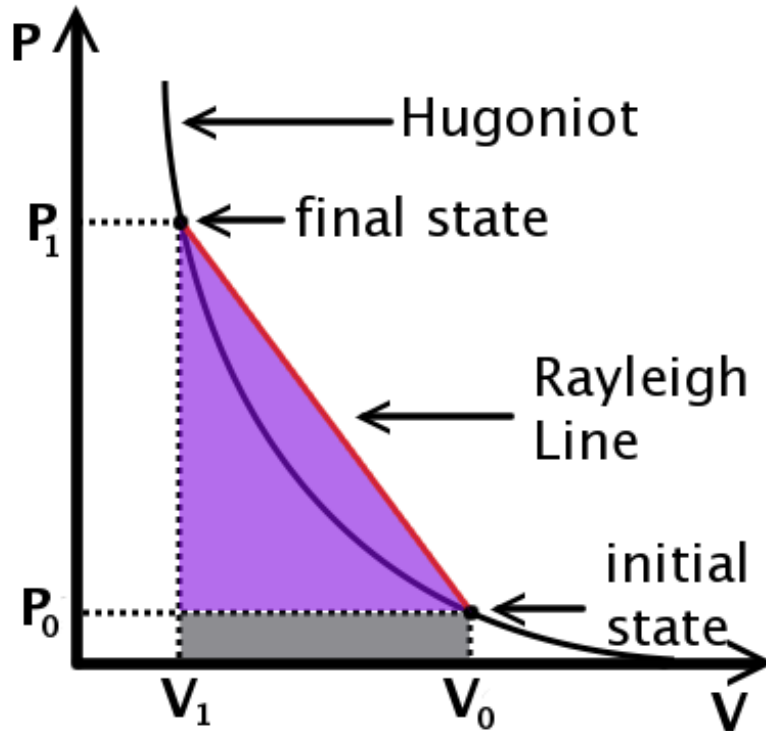

$$\frac{V_0}{V_1} = \frac{p_1(\gamma + 1) + p_0(\gamma - 1)}{p_1(\gamma - 1) + p_0(\gamma + 1)}$$

$$V_{0,1} \equiv \frac{1}{\rho_{0,1}}$$

# Pressure can be referred by measuring the shock speed with a sample with known Hugoniot curve

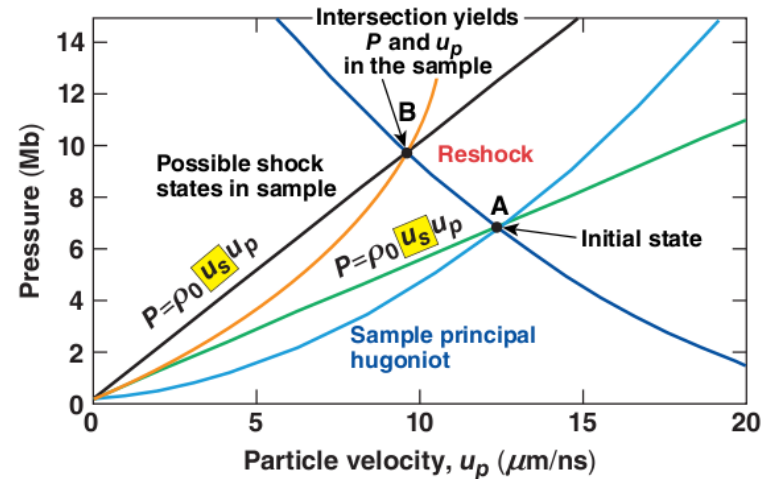
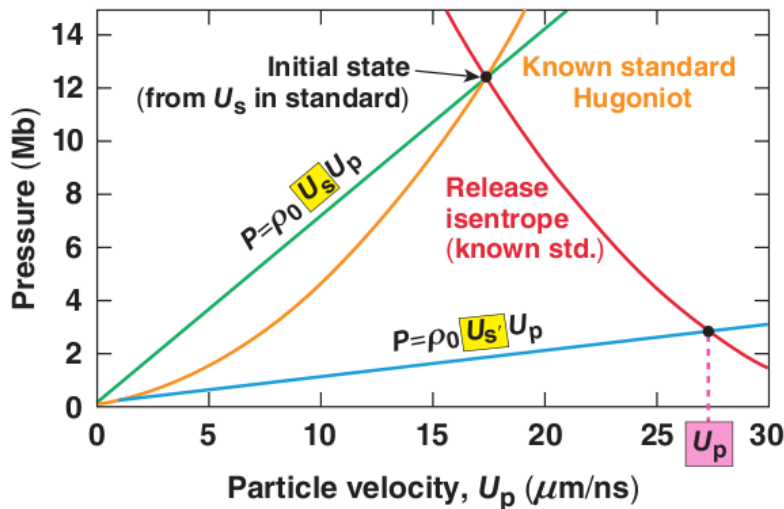
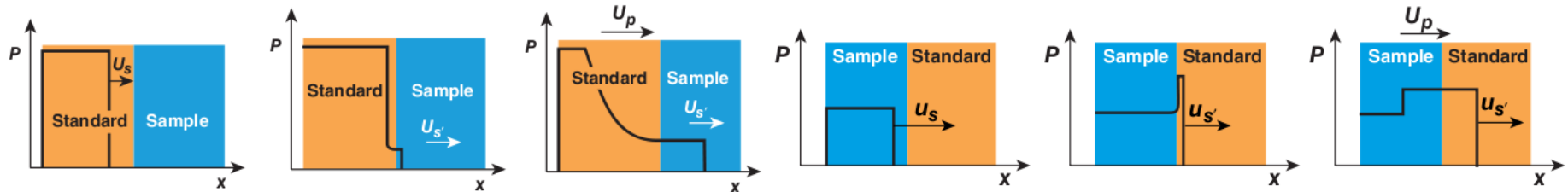

$$p_1 - p_0 = \rho_0 U_s U_p$$

**Isentrope: adiabatic flow with no change in entropy**

# Shock velocities are measured using time-resolved Velocity Interferometer System for Any Reflector (VISAR)

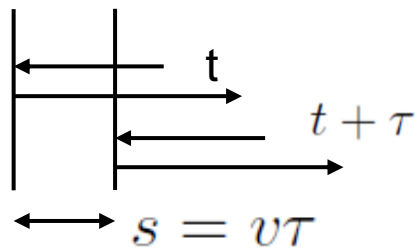
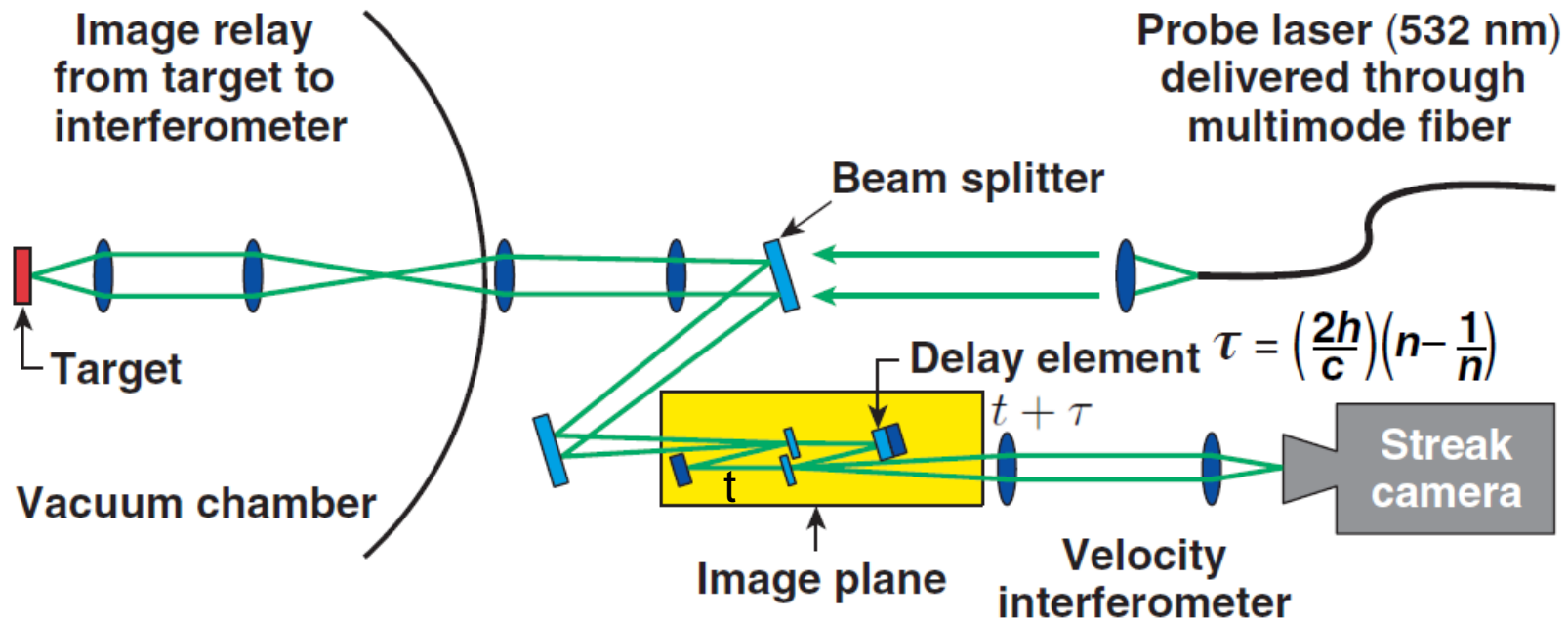

$$\Delta\phi = \frac{v\tau}{\lambda} \propto v$$

# Shock velocities are measured using time-resolved Velocity Interferometer System for Any Reflector (VISAR)

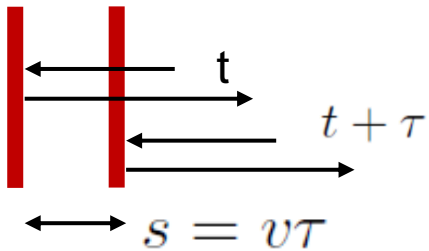
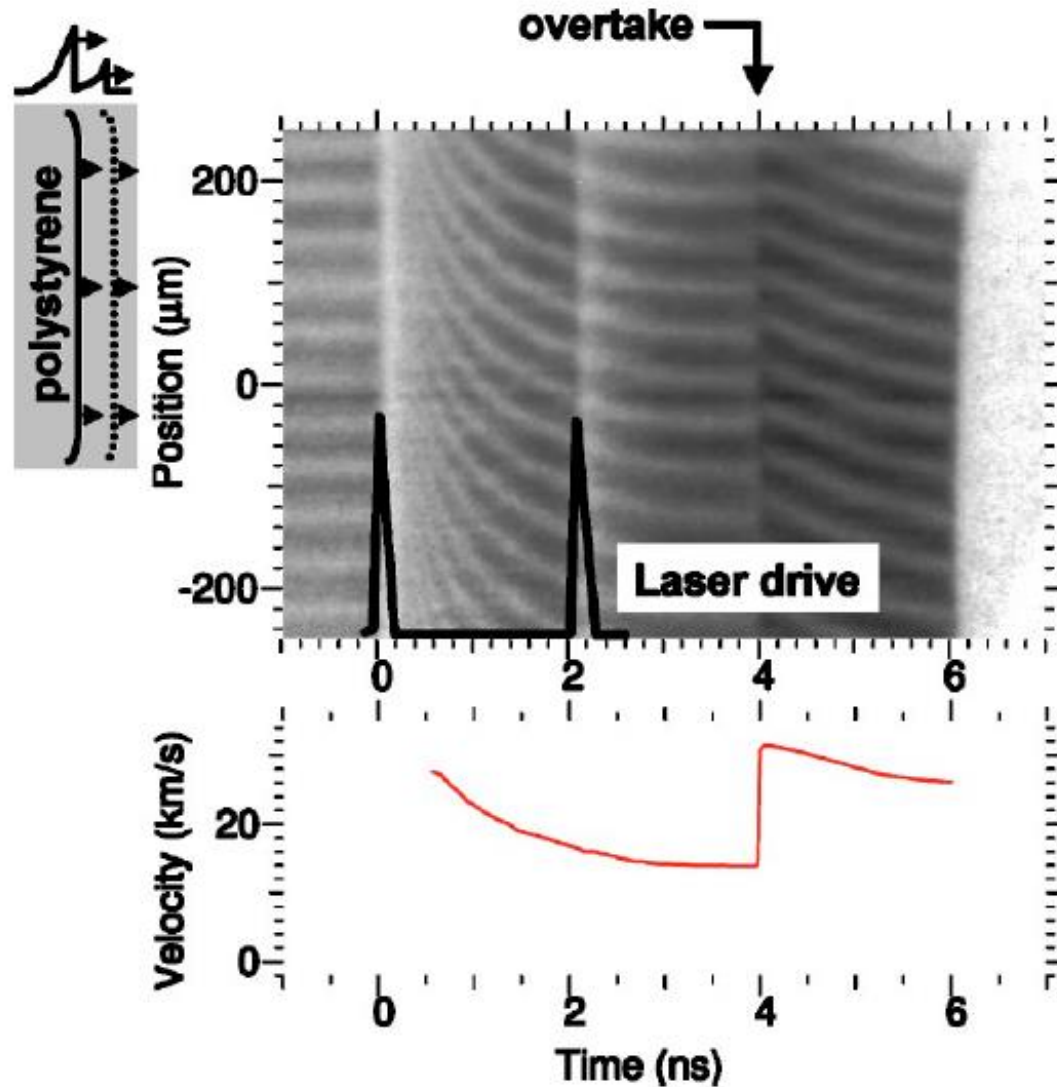



# A piston can be driven by a gas gun

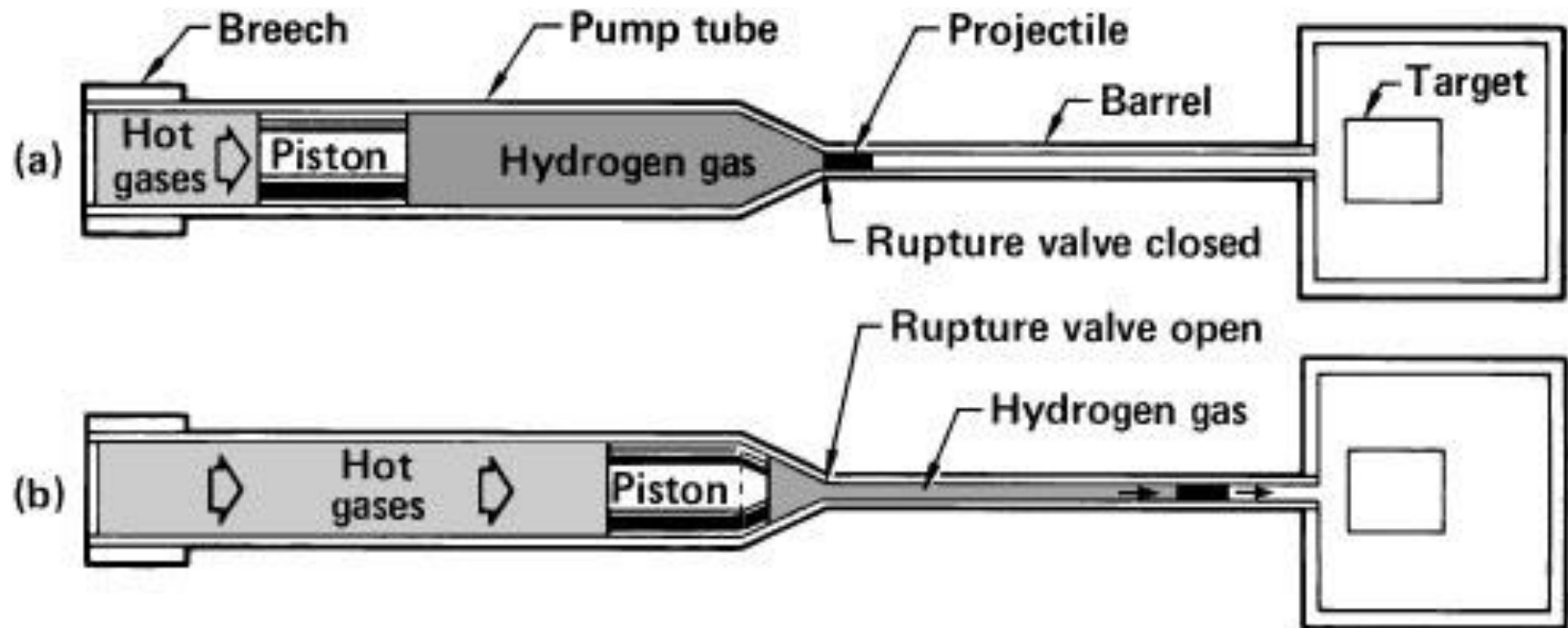

# Rochester is known as “The World's Image Center”



# There are many famous optical companies at Rochester



# Kodak

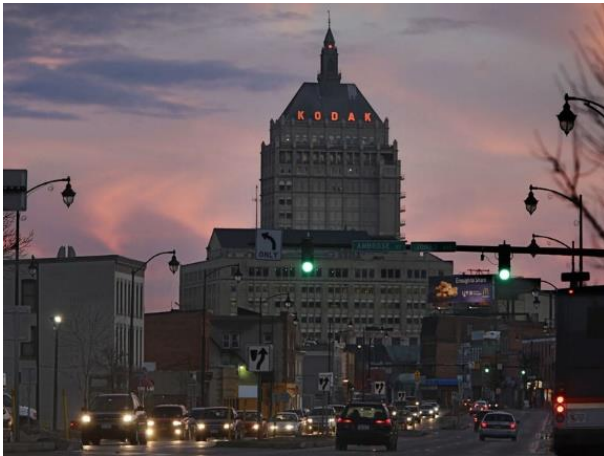

Eastman school of music



# BAUSCH + LOMB



# Laboratory for Laser Energetics, University of Rochester is a pioneer in laser fusion



- **OMEGA Laser System**

- 60 beams
- >30 kJ UV on target
- 1%~2% irradiation nonuniformity
- Flexible pulse shaping

- **OMEGA EP Laser System**

- 4 beams; 6.5 kJ UV (10ns)
- Two beams can be high-energy petawatt
  - 2.6 kJ IR in 10 ps
  - Can propagate to the OMEGA or OMEGA EP target chamber

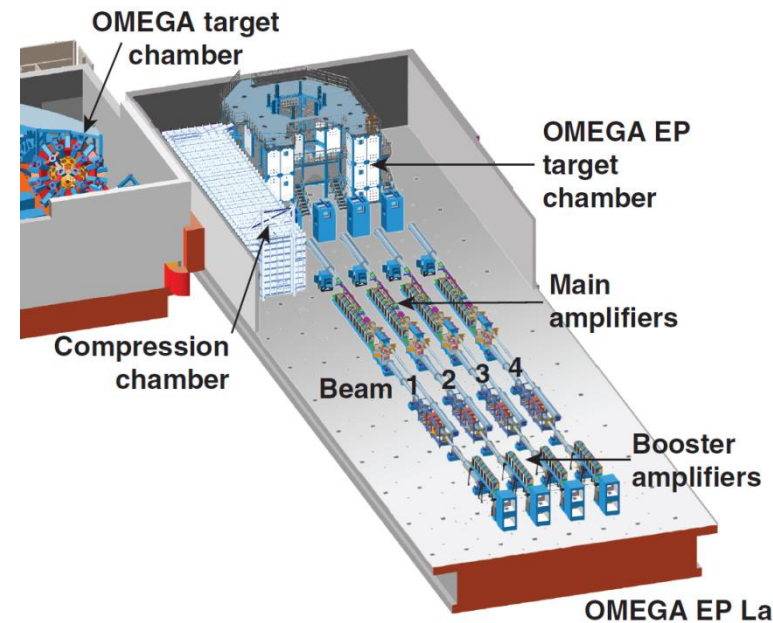
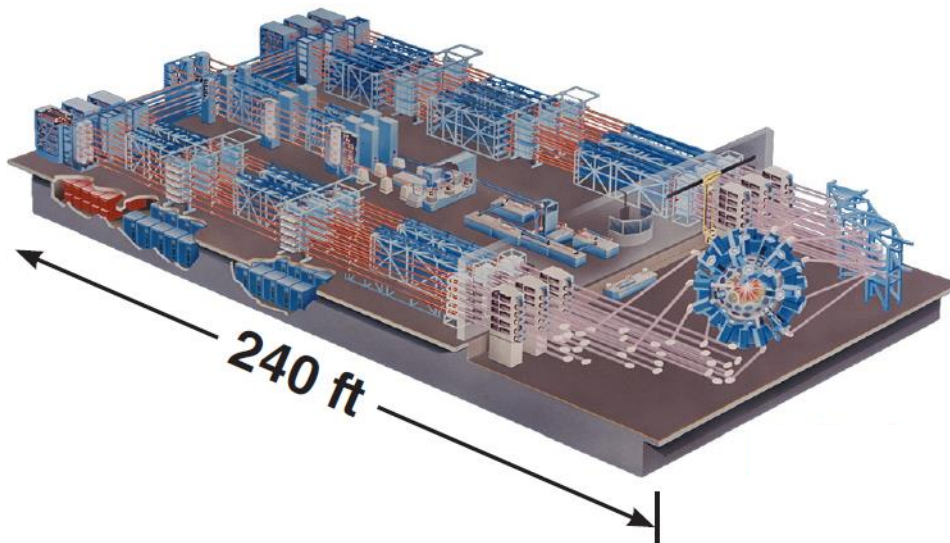

OMEGA EP Laser Bay

# The OMEGA Facility is carrying out ICF experiments using a full suite of target diagnostics

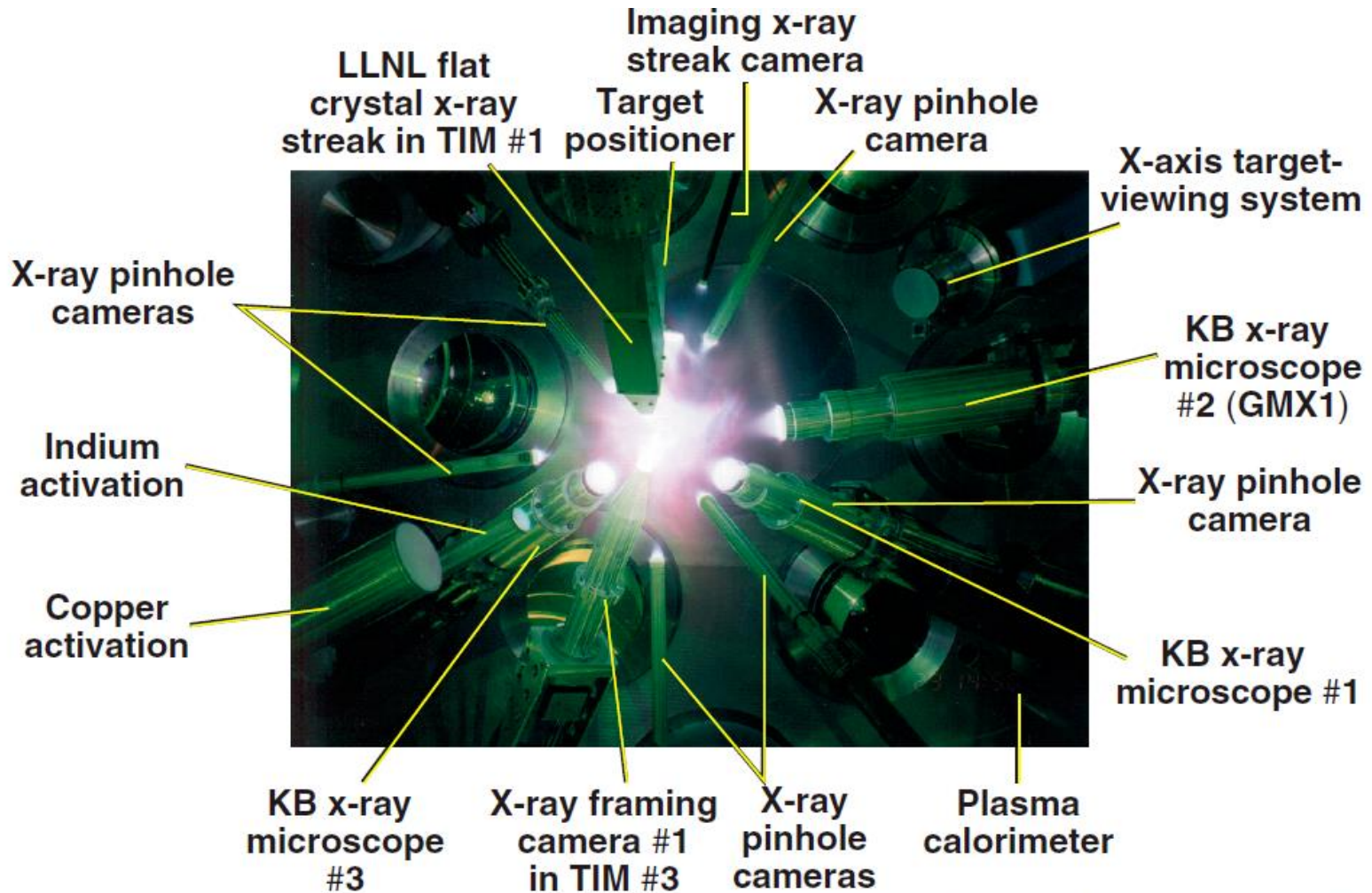
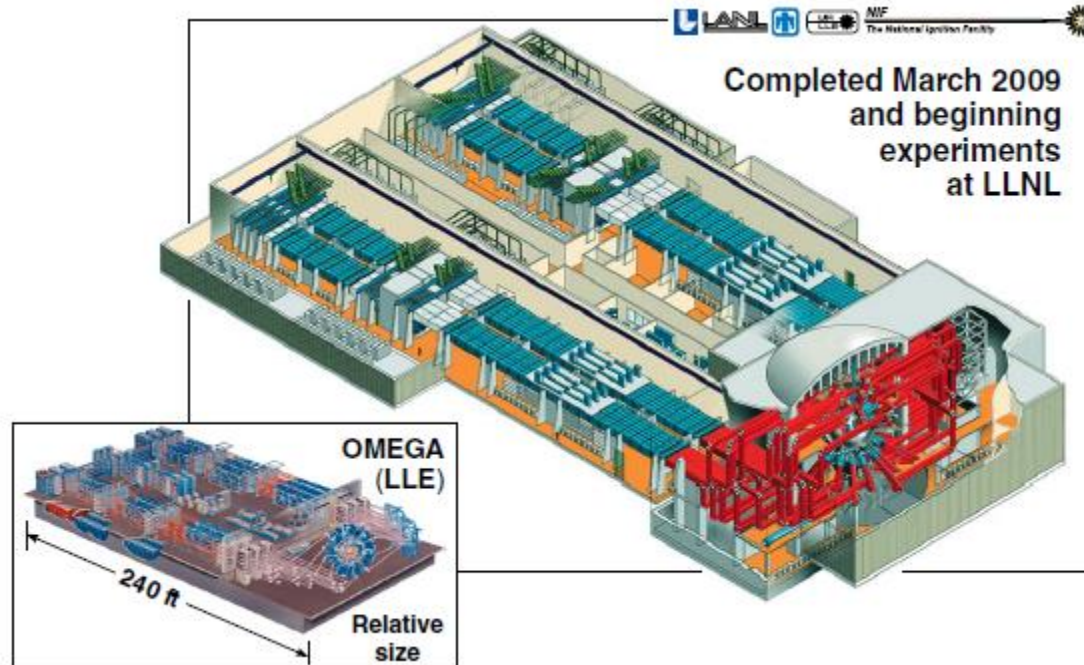

Photo taken from port H11B



# The 1.8-MJ National Ignition Facility (NIF) will demonstrate ICF ignition and modest energy gain



**OMEGA experiments are integral to an ignition demonstration on the NIF.**

# A strong shock can be generated using a high power laser

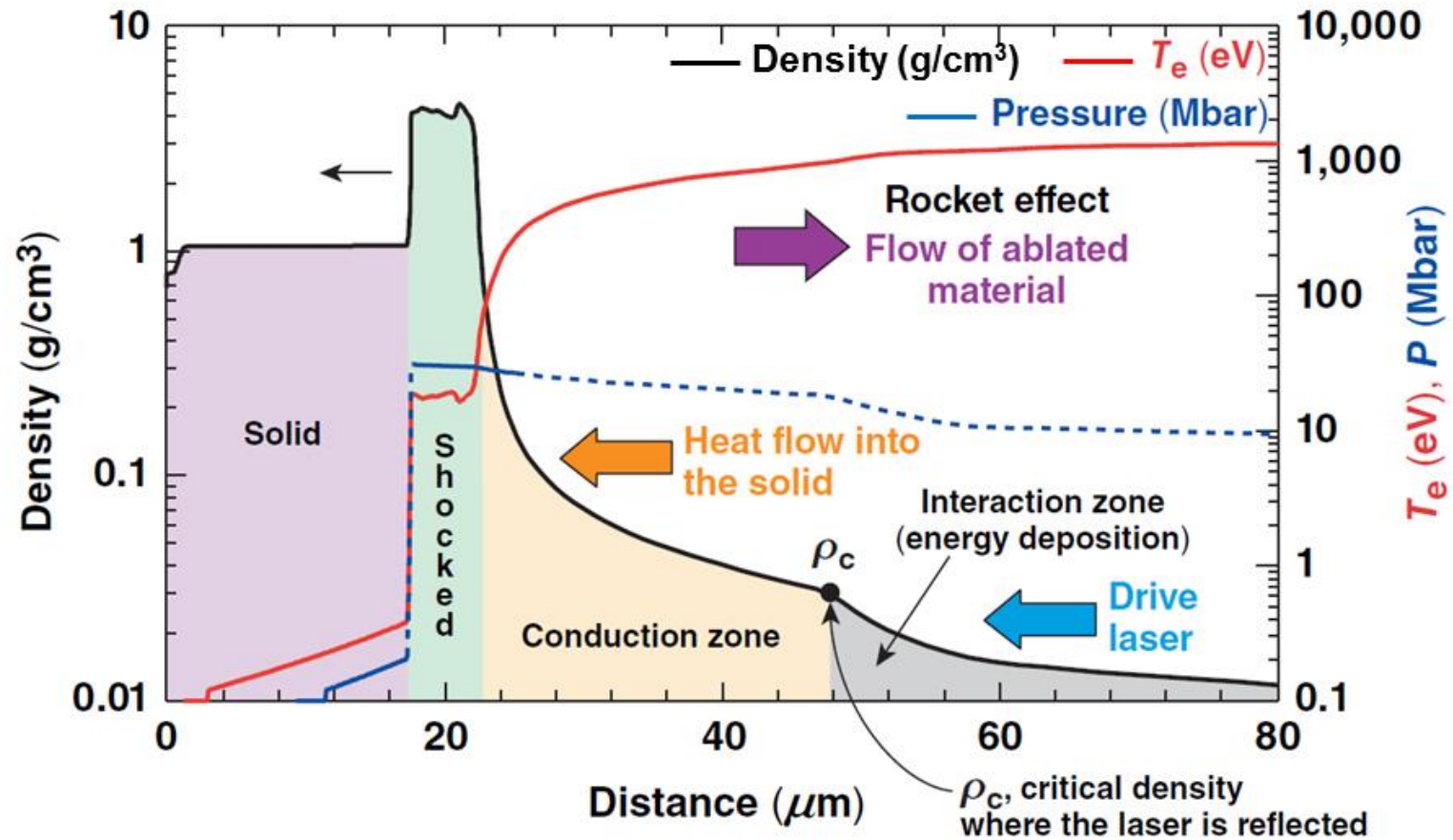

E11006d

# The powder x-ray diffraction image plate (PXRDIP) package for studying the shock phenomena

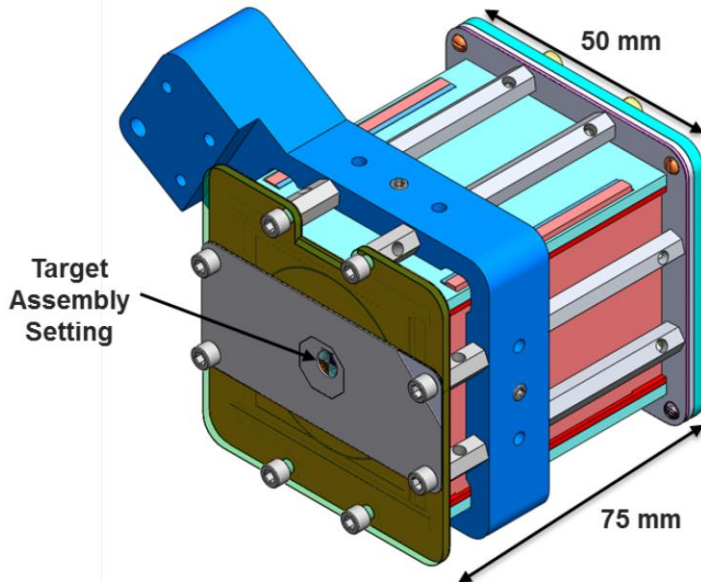
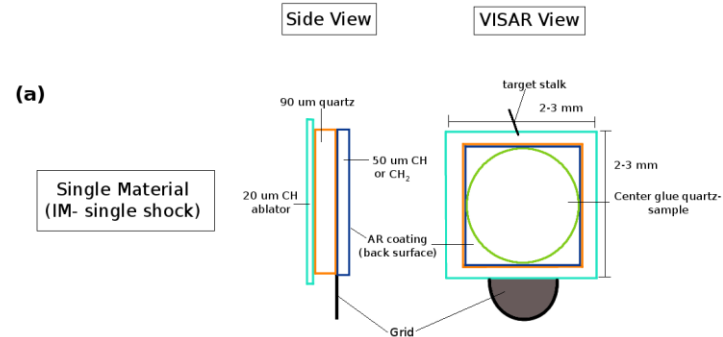
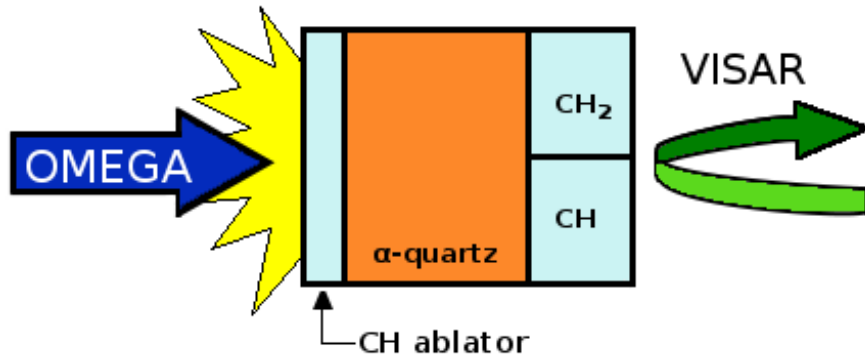

## 16 Omega beams

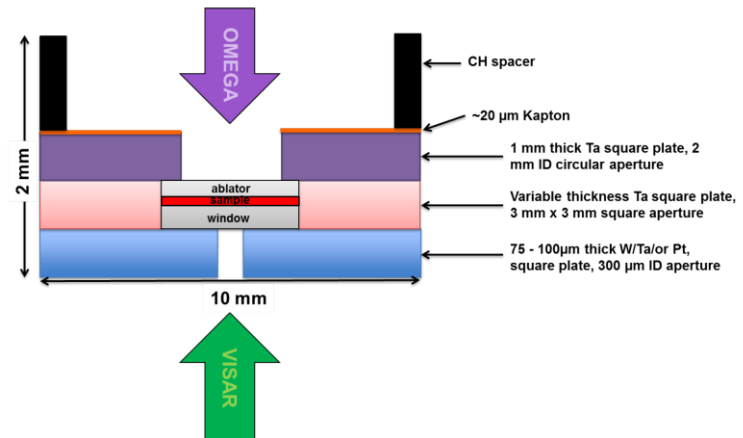

Maria Alejandra Barrios Garcia, PhD Thesis, U of Rochester, 2010  
 Danae Nicole Polsin, PhD Thesis, U of Rochester, 2018  
 J. R. Rygg, etc., Rev. Sci. Instrum. 83, 113904 (2012)

# The PXRDIP box in the chamber

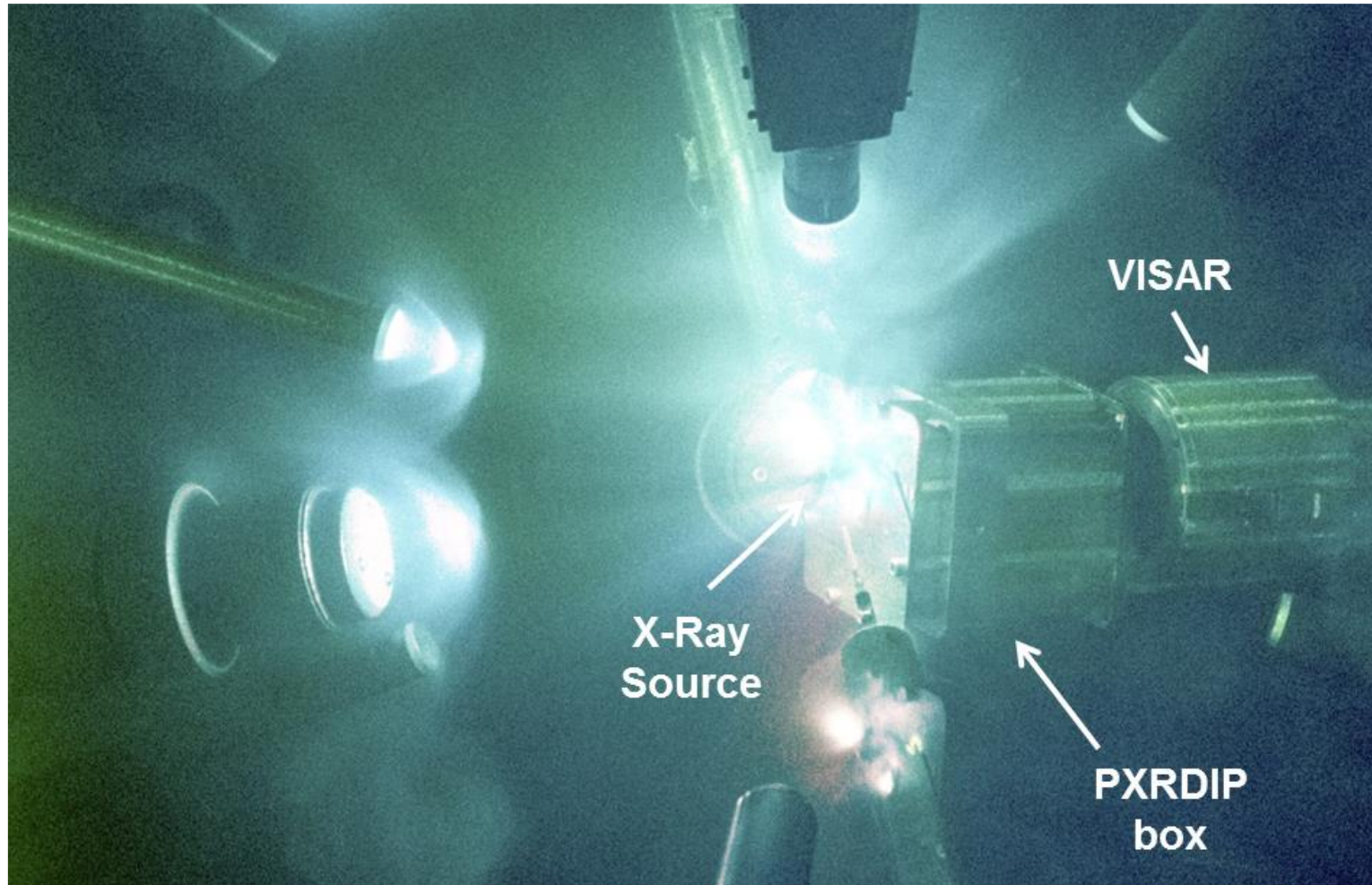



# Interference pattern shifts when a shock breakout

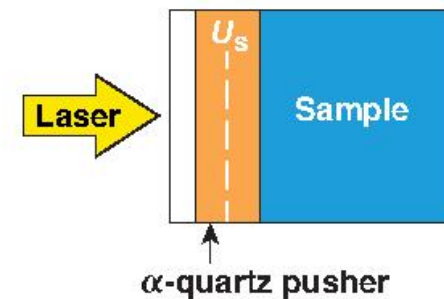
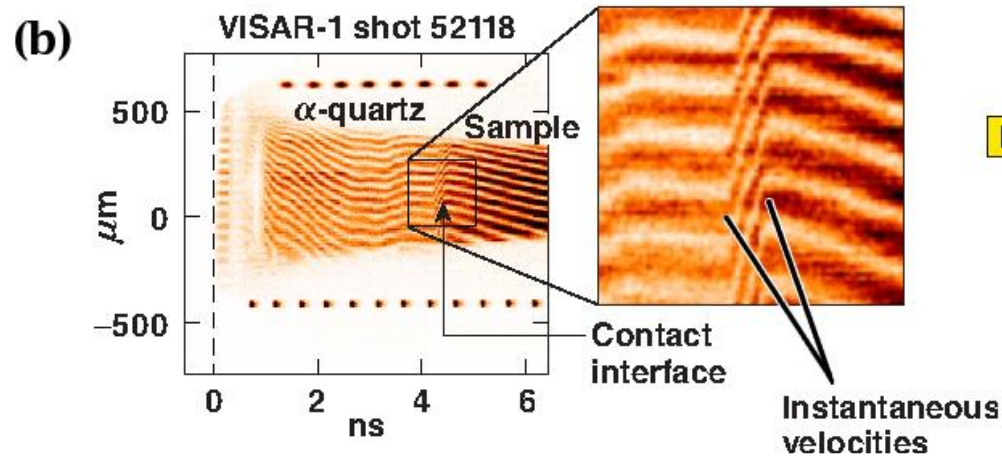
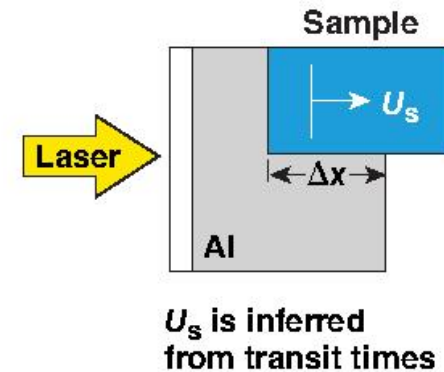
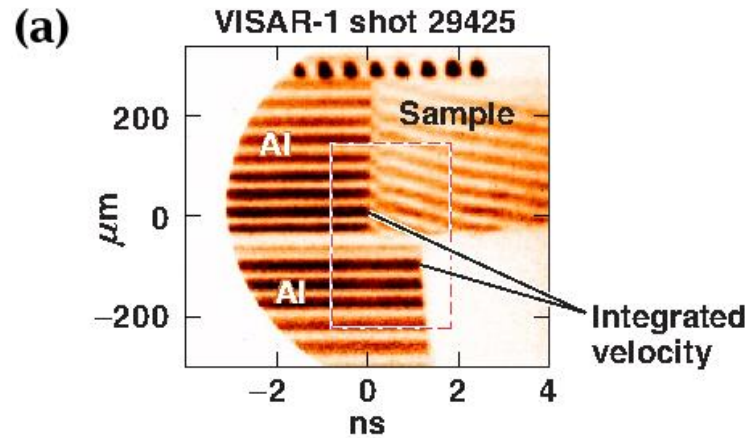



# The pressure studied using high-power laser is in the range of 1 TPa (10 Mbar)

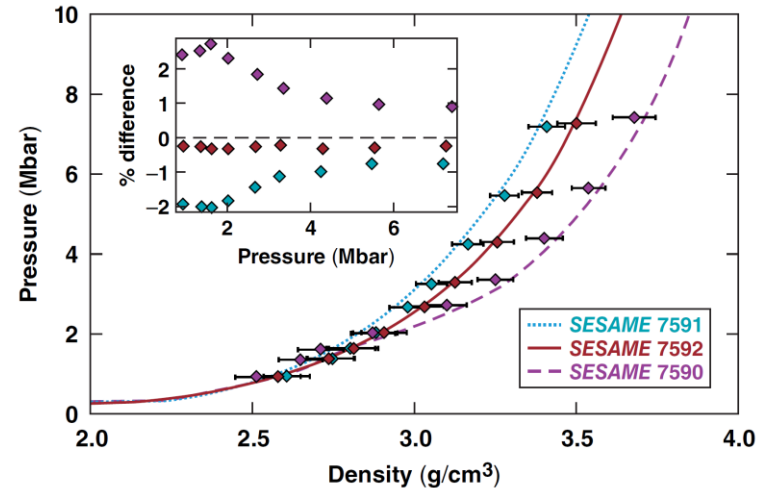
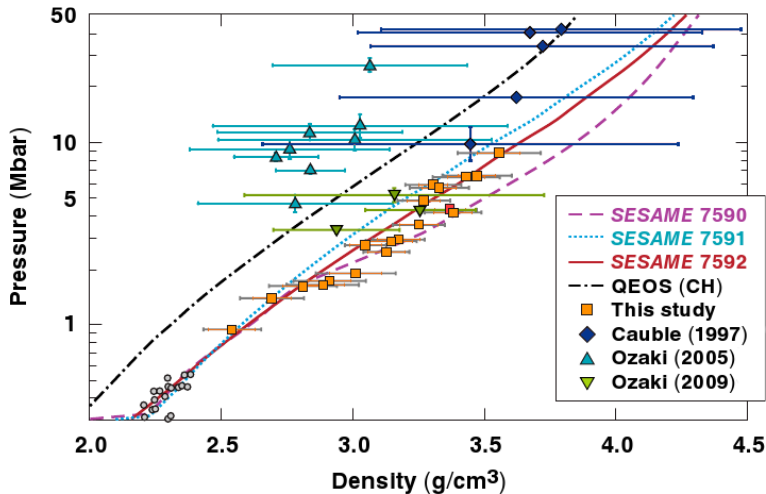
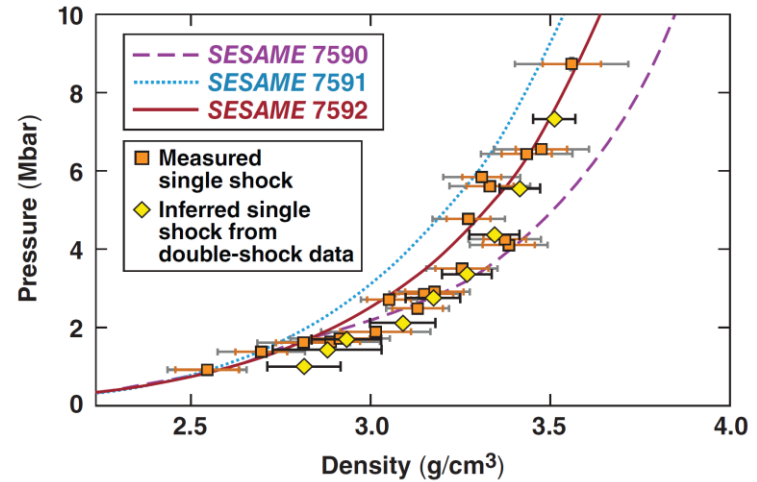

# A flyer plate can be used to as the “piston” to generate the shock in a sample

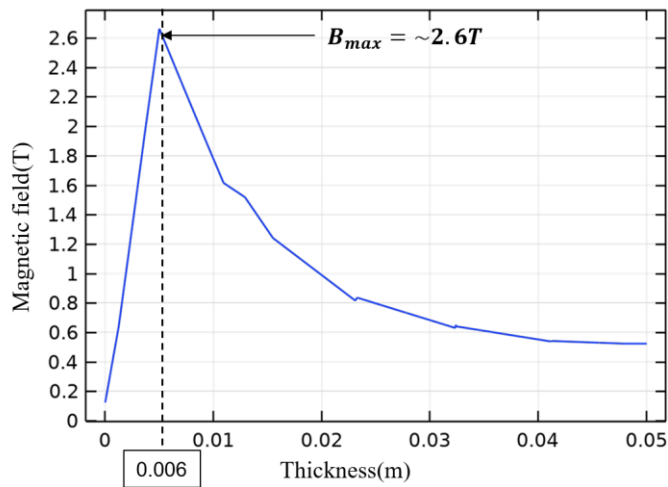
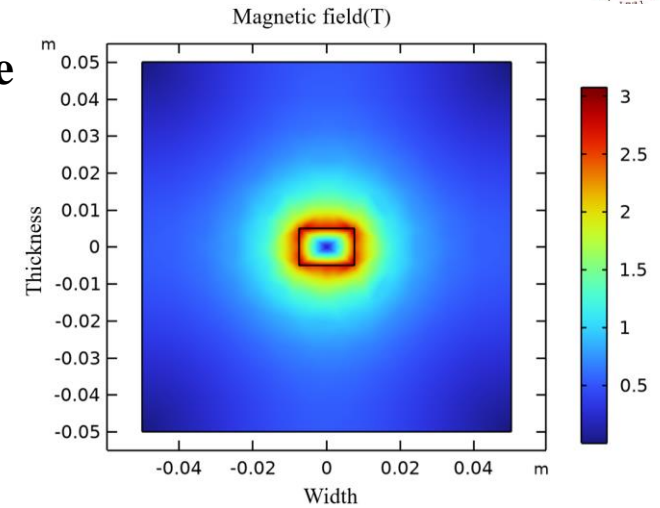
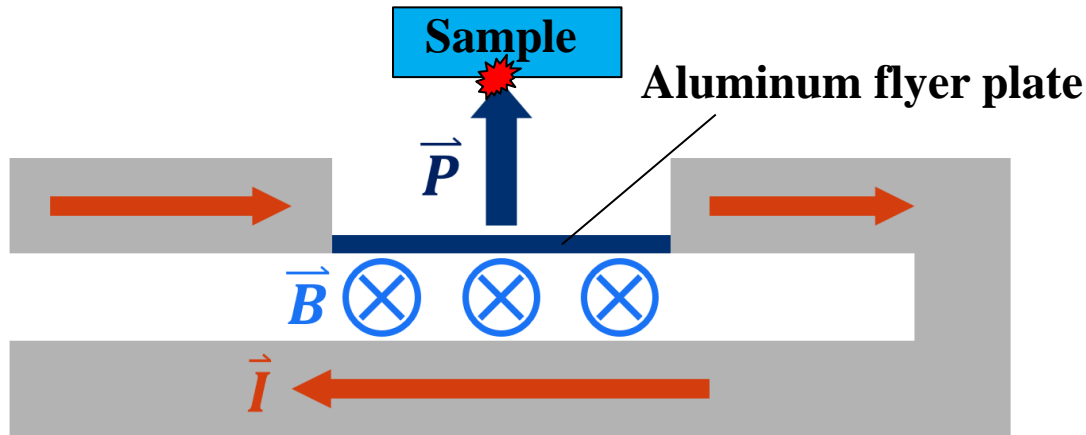

$$B = \frac{\mu_0 I}{w}$$

$$P = \frac{B^2}{2\mu_0} = \frac{\mu_0 I^2}{2w^2}$$

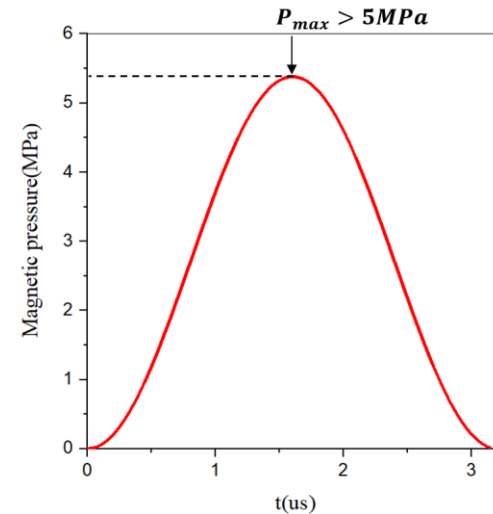

# Sandia's Z machine is the world's most powerful and efficient laboratory radiation source

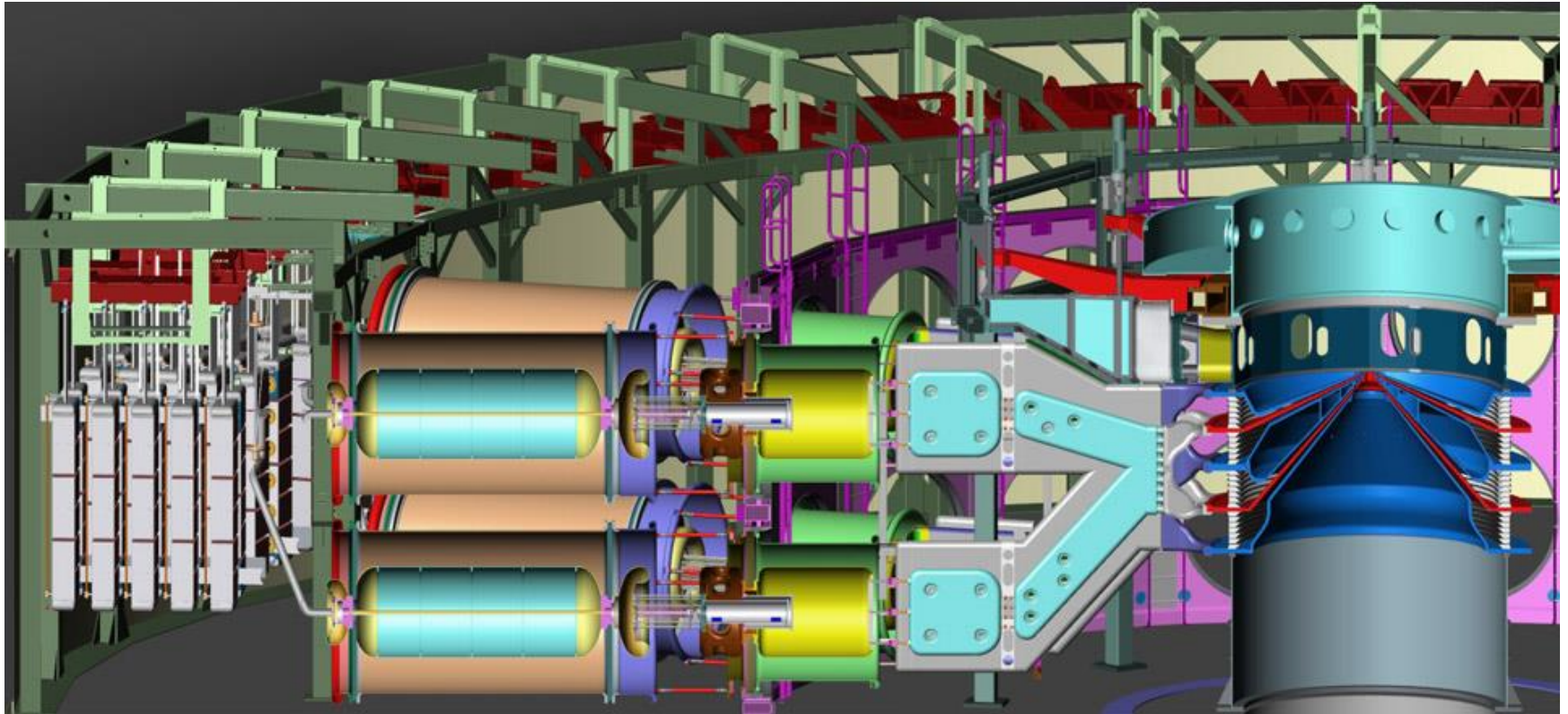

- **Stored energy: 20 MJ**
- **Marx charge voltage: 85 kV**
- **Peak electrical power: 85 TW**
- **Peak current: 26 MA**
- **Rise time: 100 ns**
- **Peak X-ray emissions: 350 TW**
- **Peak X-ray output: 2.7 MJ**



# Z machine discharge

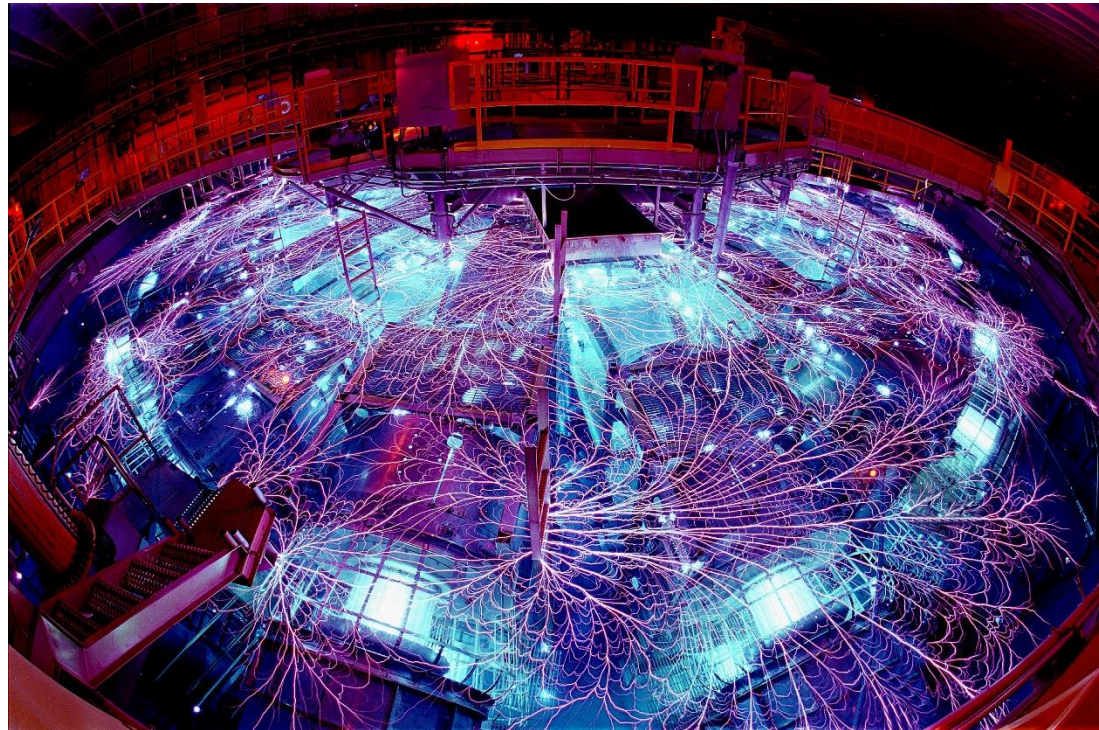

# Z machine

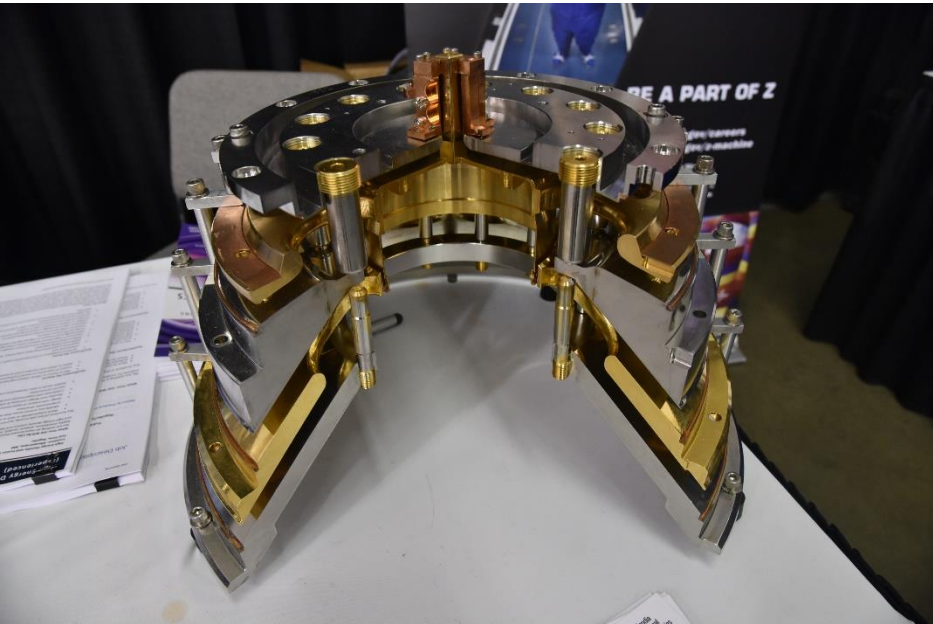



# The flyer plate used in the Z machine

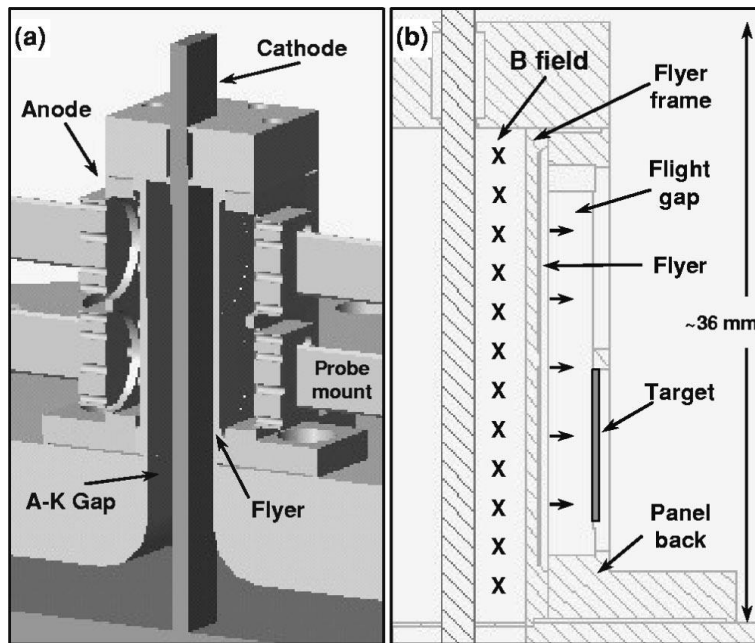

M. D. Knudson, etc., J. Applied Physics 94, 4420 (2003)  
<https://newsreleases.sandia.gov/releases/2005/nuclear-power/z-saturn.html>  
Pulsed Power Driven Experiments in the Institute of Shock Physics, by Simon Bland

# Before and after shots



- Before shots

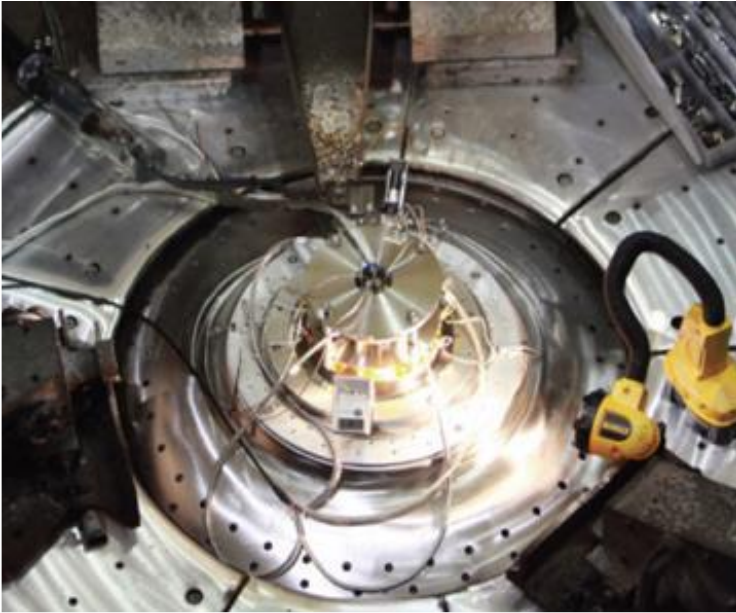

- After shots



SAND2017-0900PE\_The sandia z machine - an overview of the world's most powerful pulsed power facility.pdf

# Imperial College MAGPIE facility

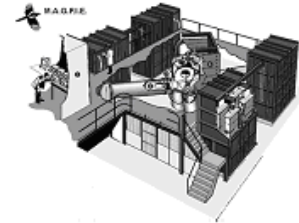

At Imperial the 1.5MA 240 ns  
MAGPIE generator drives HEDP  
experiments on a daily basis

**Mega  
Ampere  
Generator for  
Plasma  
Implosion  
Experiments**

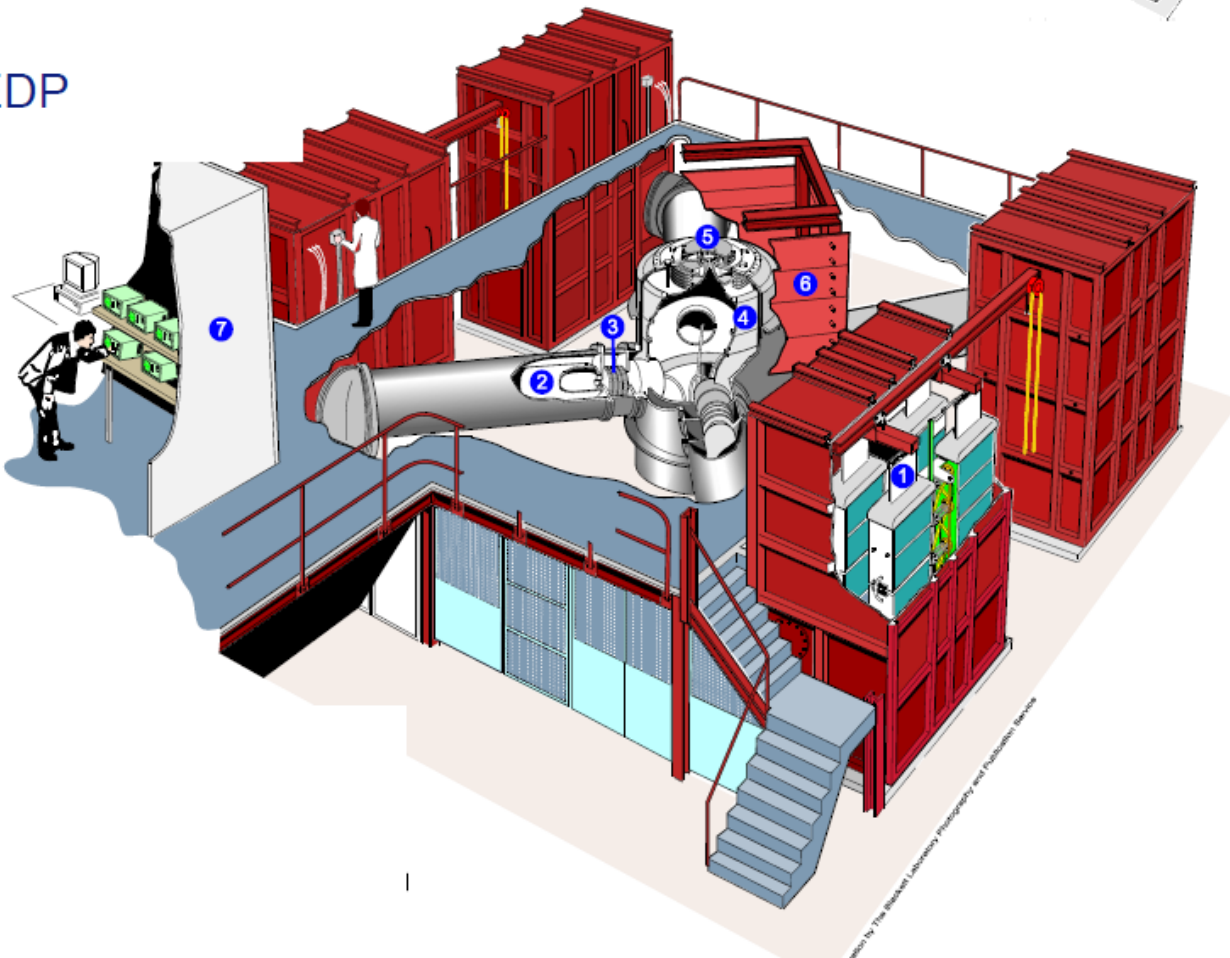

Get experience in magnetically driven isentropic compression experiments  
Can also look at shocks in plasmas - e.g. astro relevant radiative shock waves  
And using plasma explore new methods of applying high pressures to targets



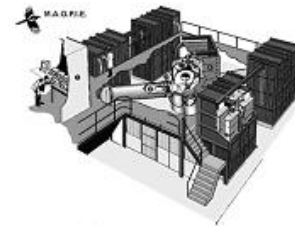

## Prelude to experiments: new power feed and vacuum chamber

Original vacuum chamber was only ~30cm diameter x 15cm tall

Anode and cathode move by 6mm during vacuum

Water ingress meant vacuum time was 3hrs

~70cm internal diameter

Chamber surrounded by 16 port plates with ISO100 and ISO 63

Reinforced steel plates to reduce flex

Rexolite diode rings increase strength reduce water absorption

New Torlon bolts don't stretch

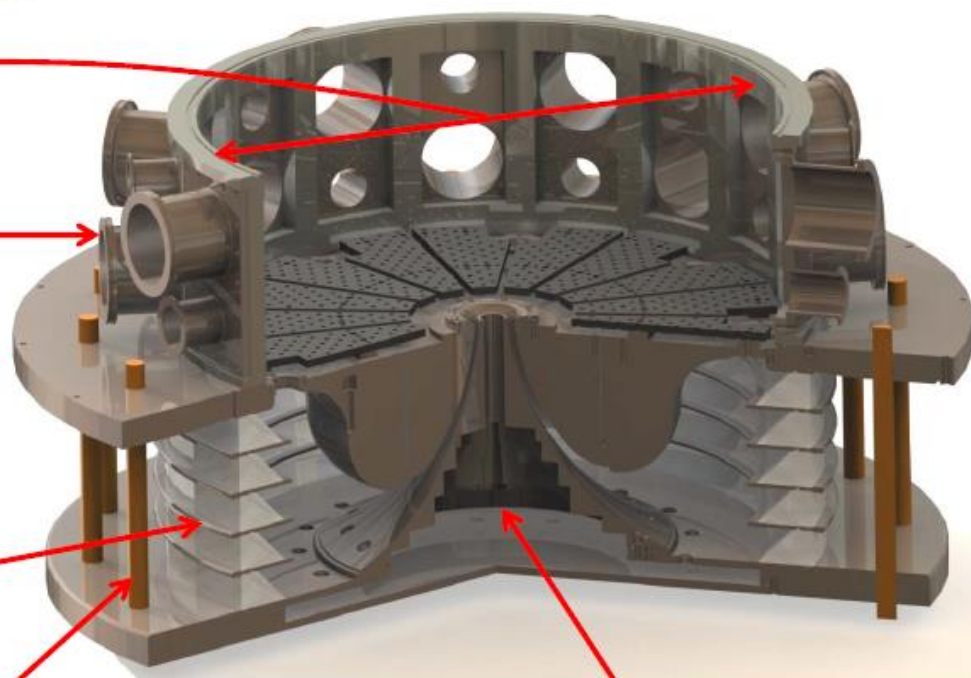

Vacuum section below MITL removes force on cathode

Anode and cathode now move ~25um

Vacuum time <1hr

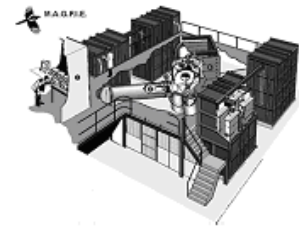

Design and manufacturing issues:

- Will the gap breakdown?
- How uniform is the drive?

EM simulations difficult due to large scale of electrodes c.f. gap in stripline...

=> electrodes designed from simple assumptions and results will serve as test for code

1 – 2 mm gap in stripline  
voltages ~200kV

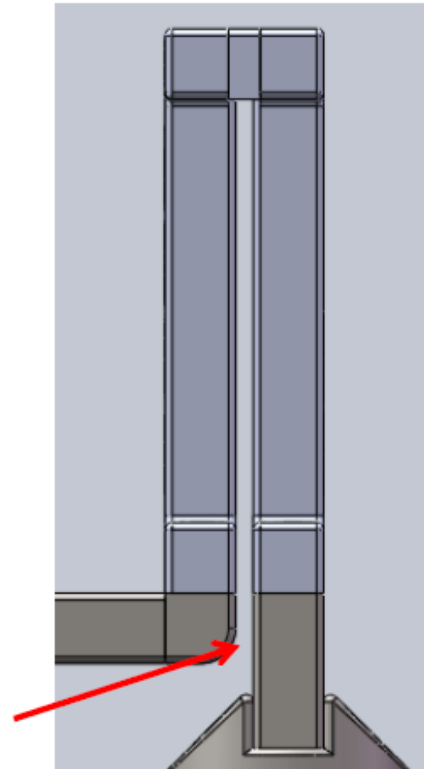

Side view of stripline

80mm

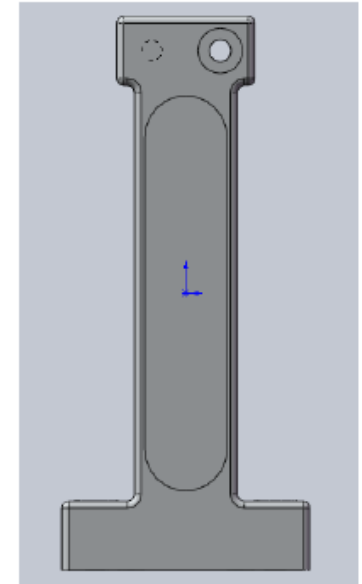

Front view of one electrode with target area outlined

- Need to use a soft material and needs to be easily machined - Copper
- Target thicknesses 1-7mm - shocks expected after ~5mm thickness
- How to support over large areas, polish etc



# Initial experiments: Feb 2010



Typically for shock experiments:

flatness  $\sim 5\mu\text{m}$ , roughness  $< \mu\text{m}$  via. diamond machining

Overkill for initial experiments (and very expensive)

Tour de Force by Imperial College Instrumentation workshop

2 part 'glued electrode' electrode - target area and support

4 axis CNC mill allows fast production of blanks

Precision ground then hand polished – mirror finish  $\sim 5\mu\text{m}$

Return electrode

Gap (2mm)

Target area  
(60x17mm)

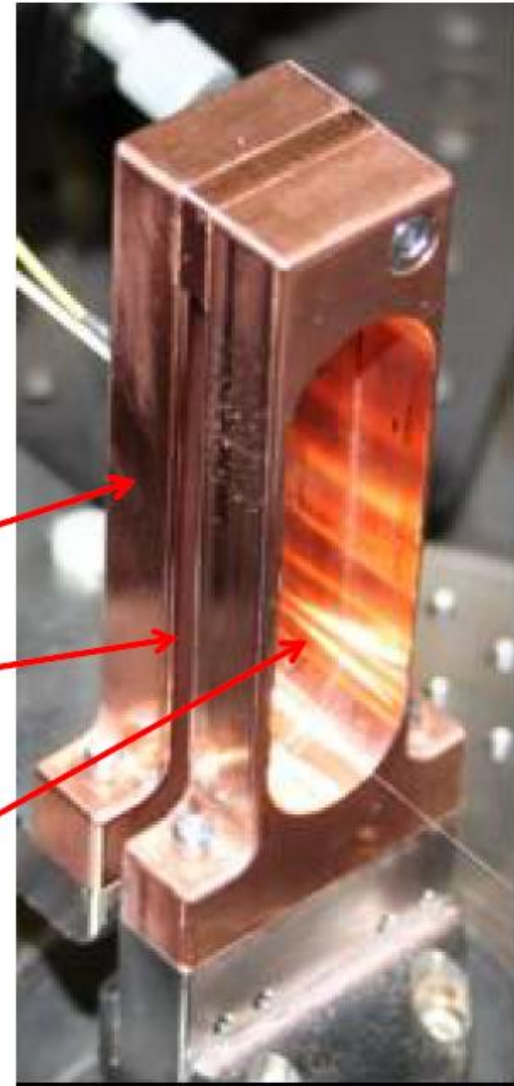

Close up of 20mm wide copper  
strip line in MAGPIE

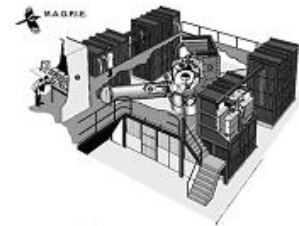

## Initial experiments: Feb 2010

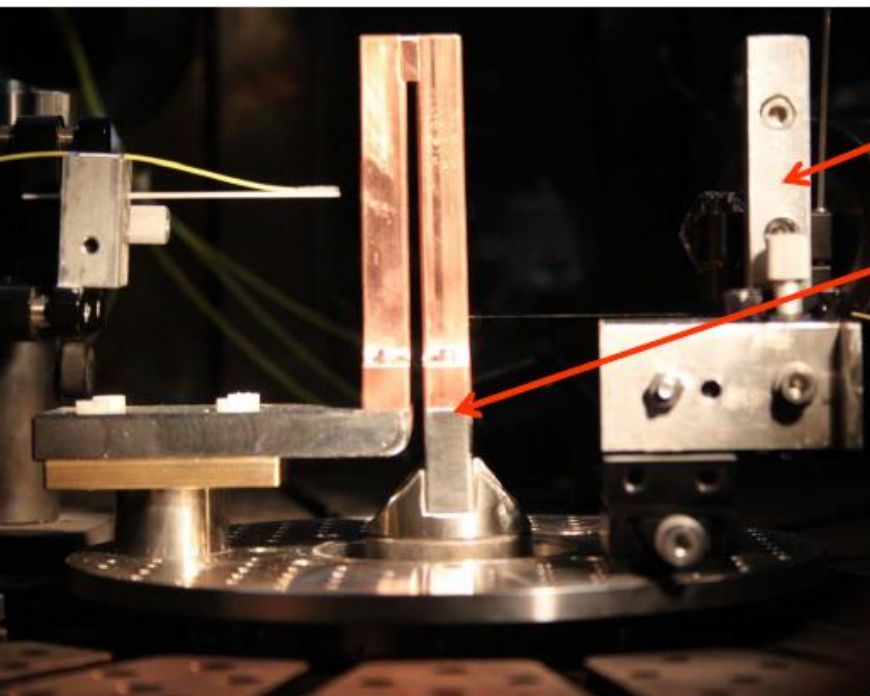

Side view of strip line

Holder for Het-V probes

Stripline mounted on break away system  
to prevent damage to MAGPIE

Top down view

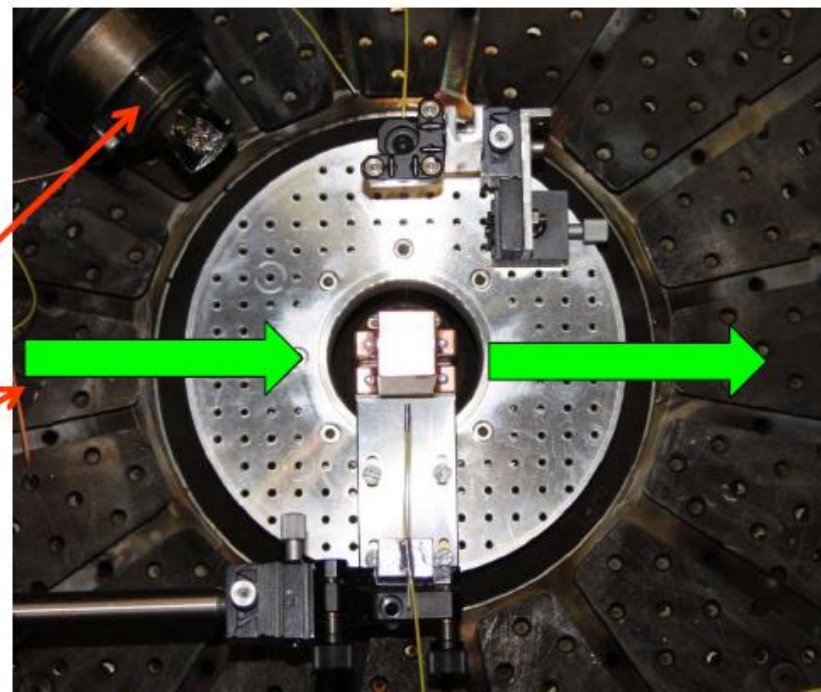

Resistive voltage probe

Path of probing laser

Pulsed Power Driven Experiments in the  
Institute of Shock Physics, by Simon Bland

1/2 inch armoured plate top and bottom  
to 'catch' stripline (not shown)





# Photos of our flyer-plate launcher



- **Assembly with target**

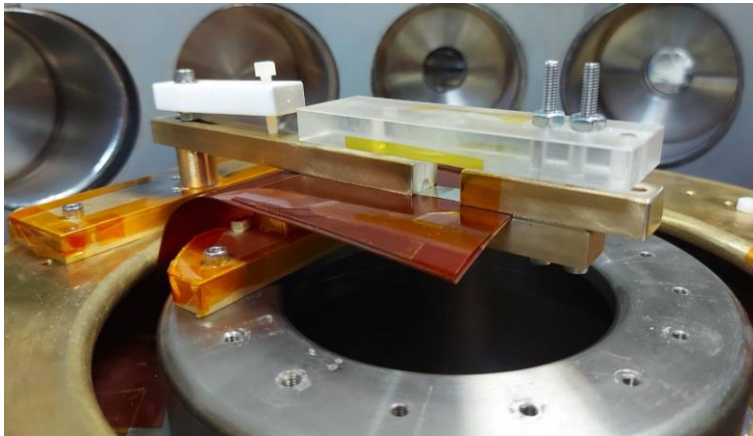

- **Assembly w/o target**

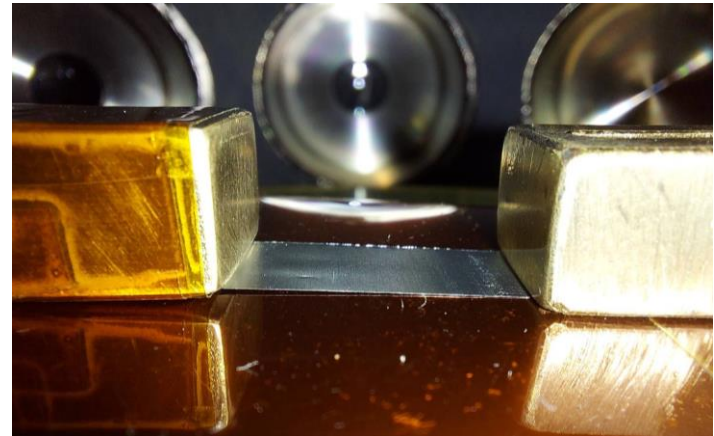

- **Self emission w/o a target**



- **Self emission w/ a target**

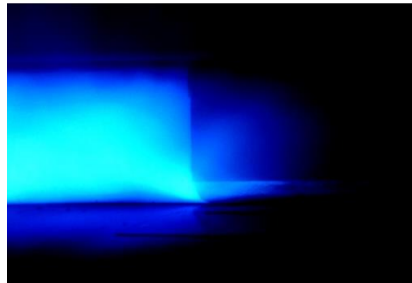

- **After shot**



# Velocities of the flyer plate were different when experiments were conducted in 1 atm and in vacuum



- @ ~1 atm

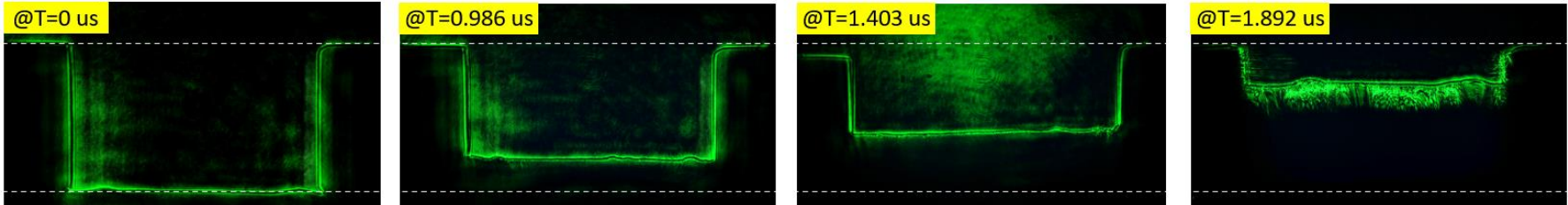

- @  $\sim 10^{-5}$  torr

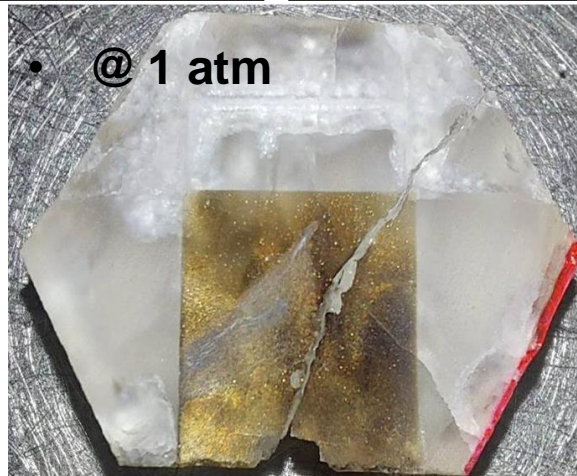
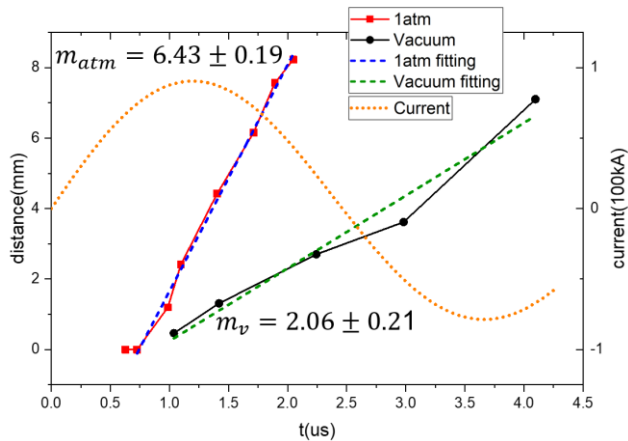
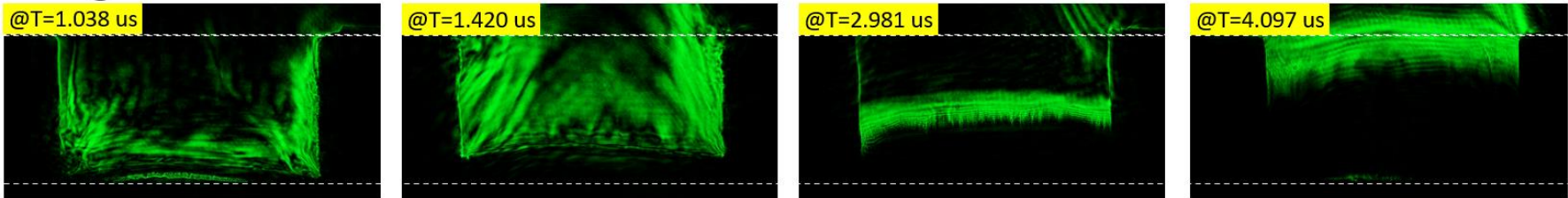

- @  $\sim 10^{-5}$  torr

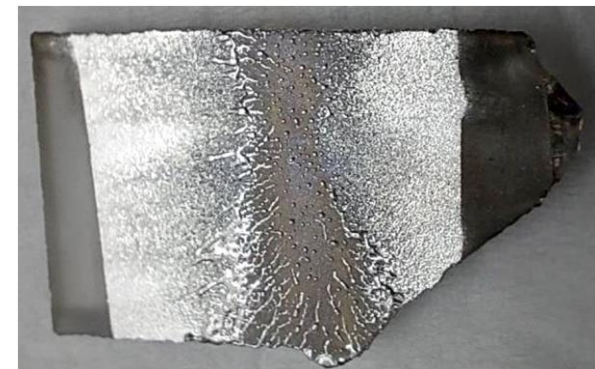



# Raman shift of the SiO<sub>2</sub> sample behaved differently after being shocked

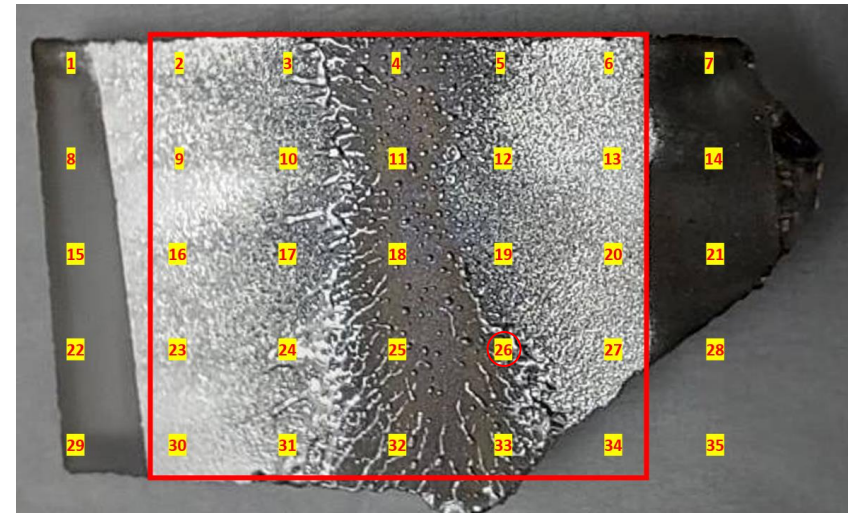
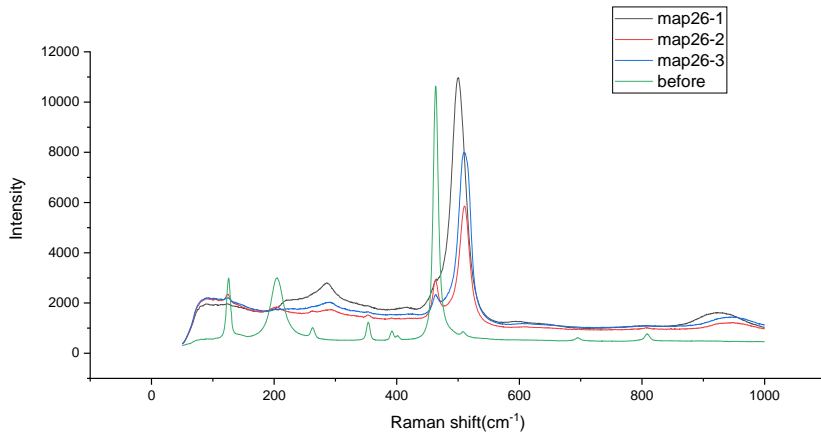
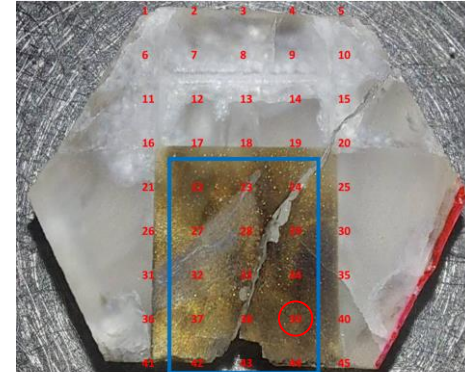
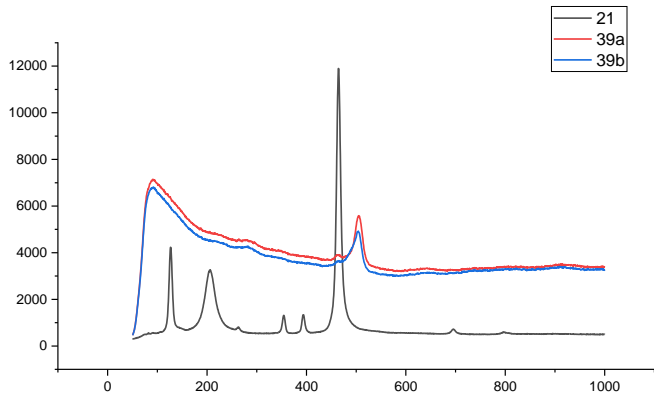

# Raman shift of 520 $\text{cm}^{-1}$ was observed suggesting that Coesite was formed

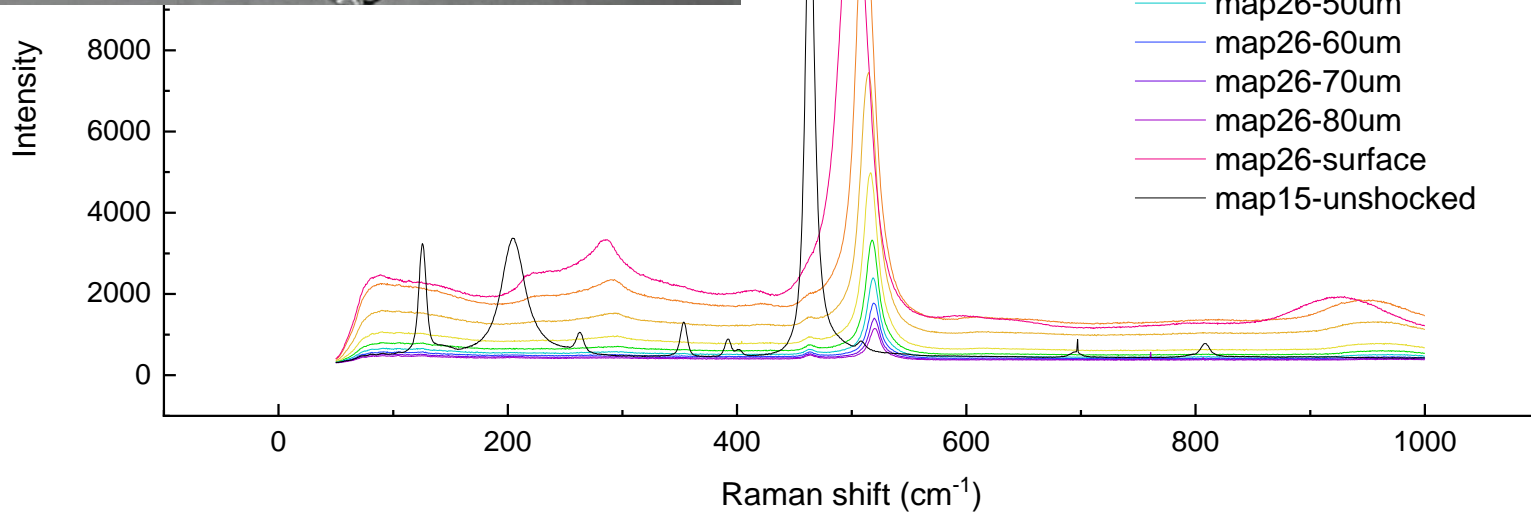
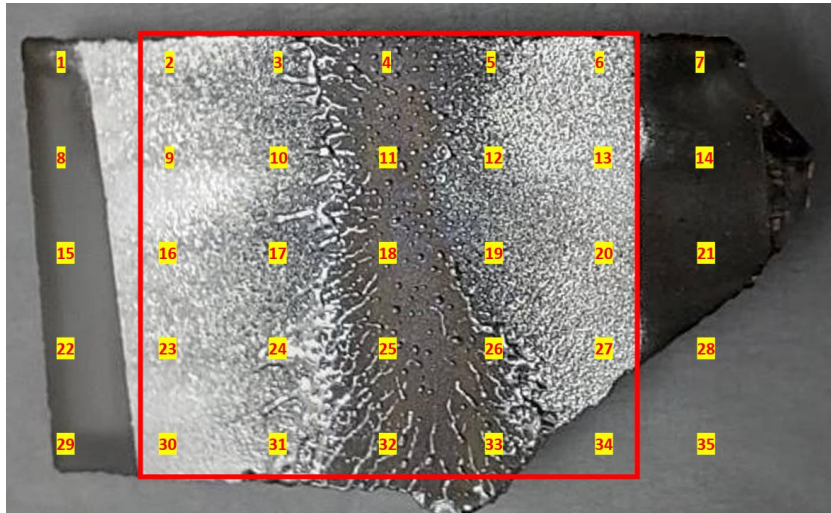

# The raman shift indicated that a pressure more than 2 Gpa was generated

